



Chair:
Prof. Paola Taroni

DOCTORAL PROGRAM IN PHYSICS

The Doctoral Program in Physics at Politecnico di Milano aims at attracting bright students with a good scientific background and a clear interest towards the development and applications of new ideas and technologies. It offers a wide range of opportunities in the fields of advanced applied physics, such as photonics and optoelectronics (lasers, ultrafast optics), biomedical optics (optical tomography), vacuum technologies (thin film depositions), material technologies (microelectronics and nanotechnologies, micromechanical processing), and advanced instrumentation (electronic and atomic microscopy, nuclear magnetic resonance). Scientific education and training to develop general research abilities in all areas of applied physics is increasingly needed by advanced technological companies. Through a general education in the basic areas of applied physics and a specific knowledge in condensed matter physics, as well as optics and lasers, the PhD Program aims at the development of an experimental approach to problem solving techniques and at the attainment of a high level of professional qualification.

The Doctoral Program has a strong experimental character. The contents are strictly related to the research activities carried out in the laboratories at the Department of Physics. They can be divided into two main areas:

- a) Condensed Matter Physics, including photoemission; spin-resolved electronic spectroscopy; magneto-optics; X ray diffraction; magnetic nanostructures for spintronics; synchrotron radiation spectroscopy, positron spectroscopy, semiconductor nanostructures.
- b) Optics and Quantum Electronics, including ultrashort light pulse generation and applications; UV and X optical harmonics generation; biomedical applications of lasers; diagnostics for works of art; laser applications in optical communications; time domain optical spectroscopy and diagnostic techniques.

All research activities rely on advanced experimental laboratories located at Politecnico di Milano (Milano-Leonardo Campus and Como Campus) and are performed in collaboration with several international Institutions. Besides the experimental research, a consistent effort is devoted to the design and development of novel instrumentation.

The educational program can be divided into three parts: 1) Main courses specifically designed for the PhD program; 3) Activities pertaining to more specific disciplines which will lay the foundation for the research work to be carried out during the Doctoral Thesis;

4) Doctoral Thesis. The thesis work is the major activity of the Program. It has a marked experimental character, and will be carried out in one or more laboratories at the Department of Physics.

The students are also encouraged to perform part of their thesis work in laboratories of other national or foreign Institutions. Collaborations that may involve the PhD students are presently active with several national and international research and academic Institutions, such as: ETH-Zürich, EPL-Lausanne, Lund Institute of Technology, University of Paris-Sud, Ecole Polytechnique-Paris, University of Barcelona, University of Berkeley, University of Cambridge, Technical University of Wien, University of Bordeaux, Massachusetts Institute of Technology, Harvard University, INFN-CNR, IIT-Istituto Italiano di Tecnologia, European Space Agency, ENEA, Elettra-Ts, PSI-Villigen, Agenzia Spaziale Italiana, European Synchrotron Radiation Facility (ESRF-Grenoble).

The average number of fellowship/grants for students admitted to the PhD Program is twelve per year, while the average number of available positions is more than double. At present, the overall number of students in the three-year course is fifty-six.

Teaching and research activities of the Doctoral Program are controlled and organized by a number of Faculty members large enough to cover a wide spectrum of research fields. All members are highly qualified and active researchers. This ensures a continuous updating of the PhD program and guarantees that the

students are involved in innovative work. A list of the Faculty members follows:

FAMILY NAME	FIRST NAME	POSITION*
BERTACCO	RICCARDO	AP
BRAMBILLA	ALBERTO	AP
CICCACCI	FRANCO	FP
CUBEDDU	RINALDO	FP
DALLERA	CLAUDIA	AP
D'ANDREA	COSIMO	AP
DELLA VALLE	GIUSEPPE	PA
DE SILVESTRI	SANDRO	FP
DUÒ	LAMBERTO	FP
FINAZZI	MARCO	AP
GHIRINGHELLI	GIACOMO	AP
ISELLA	GIOVANNI	PA
LANZANI	GUGLIELMO	FP
LAPORTA	PAOLO	FP
MARANGONI	MARCO	AP
NISOLI	MAURO	FP
RAMPONI	ROBERTA	FP
STAGIRA	SALVATORE	PA
TARONI	PAOLA	FP
TORRICELLI	ALESSANDRO	AP

*Position: FP = Full Professor; AP = Associate Professor; RC = Researcher/Assistant Professor

The Doctoral Program relies also on the advice of a Steering Committee, formed by distinguished experts (see table below) coming from R&D industries or research laboratories, taking care that the goals of the PhD Program are in line with the needs of the non-academic world.

FAMILY NAME	FIRST NAME	INSTITUTION
PIROVANO	AGOSTINO	Micron Semiconductor Italia s.r.l.
DONATI	FABIO	EPFL – Lausanne, CH
MIOZZO	LUCIANO	Solvay Specialty Polymers
von KÄENEL	HANS	ETH – Zürich, CH
MASOTTI	GIOVANNI	El.En. S.p.A

STUDY OF THIN FILMS AND MESOPOROUS MATERIALS BY MEANS OF POSITRON ANNIHILATION SPECTROSCOPY FOR APPLIED AND FUNDAMENTAL PHYSICS

Stefano Aghion - Supervisor: **Rafael Ferragut**

My PhD research activity was focused on the use of positrons, the anti-particle of the electron, both as a probe for material properties and as a fundamental element for the production of antihydrogen at the CERN laboratories. Positron annihilation spectroscopy is a consolidated technique for the study of defects in metals, alloys and semiconductors as well as for the analysis of free volumes inside polymer materials. At VEPAS laboratory (Variable Energy Positron Annihilation Spectroscopy), L-NESS (Laboratory for Nanostructure, Epitaxy and Spintronics on Silicon, Politecnico di Milano, Polo territoriale di Como), a slow energy positron beam and a bulk positron lifetime spectrometer have been employed to the study of thin films, hybrid solar cells and PMMA polymers in order to correlate positron spectroscopy information to the electrical and optical properties of the materials. The chemical composition and the morphology of voids and porosities in hybrid solar cells and thin film metal oxide semiconductors - IGZO in particular - have been studied and a strong correlation between the positron spectroscopy results and the electrical properties of materials have been found. In

a PMMA polymer, free volume measurements have showed that the material optical properties depend even on slight changes in the free volumes dimensions and concentration. Positron annihilation spectroscopy techniques have also been applied to the study of positron to positronium converters for the AEGIS (Antimatter Experiment: gravity Interferometry spectroscopy) experiment at CERN (Geneve, Switzerland). The AEGIS experiment will produce antihydrogen by overlapping a cold antiproton cloud and a cold, laser excited, positronium cloud, therefore an efficient yield of positronium is crucial for the experiment fulfillment. The AEGIS experiment is one of the five experiments in the world that works with low energy antiprotons. The antiproton decelerator AD at CERN, a very unique facility, delivers bunches of cold antiprotons. The only way to study antimatter properties with a good enough resolution is to cool (i.e. to lower the kinetic energy) and catch antiatoms in electromagnetic traps; the lower their kinetic energy, the more accurate the measurements can be performed. The principal aim of the AEGIS experiment is to measure the antihydrogen gravitational acceleration g on earth, i.e. to test the Weak

Equivalence Principle (WEP) for antimatter. The WEP is one of the cornerstones of Einstein's General Relativity, which states that the trajectory of a free fall body does not depend on its composition but only on its initial kinematic conditions (position and velocity). The gravitational interaction is the only one, among the four fundamental interactions (gravity, electromagnetic, weak and strong) described by a classical theory, General Relativity, and not by a quantum field theory. Therefore the g measurement for an antimatter system could in principle shed light on which quantum model could describe the gravitational interaction. In a second phase of the experiment antihydrogen spectroscopy will be performed in order to verify the Charge Parity Time theorem (CPT), which states the symmetry between the properties of matter and antimatter. At CERN I had the opportunity to cooperate in the setup of the *AEGIS pulsed positron beam* that delivers positrons to the AEGIS central region in which antihydrogen will be produced in the near future. I also participated to the antiproton runs during which antiprotons were successfully cooled and stored for hours inside the apparatus electromagnetic traps. Among the several samples

suitable as positron to positronium converters studied at L-NESS, silica Aerogel 85 and MCM-41 represent the best candidates. They are mesoporous silica characterized to have a very low density and a very high porosity. Aerogel 85 in particular has a density of 85 mg cm^{-3} and a porosity of 96 % and has been developed by the NASA to be applied in the Stardust Project as particle collector in the space. When a silica aerogel sample, or MCM-41 sample, is used as a target of a positron beam, positronium atoms are formed inside the interconnected pores and then escape into vacuum from the sample surface. The common geometry used for the production of positronium atoms is the backscattering geometry: positronium atoms are emitted from the same surface where the positrons are implanted. Since for many experiments that involve high positronium yield in vacuum, like the AEGIS experiment but in general all the experiments for the study of positronium properties, positronium formation in transmission geometry is very promising, Aerogel 85 properties have been used to simulate a cold positronium yield in vacuum using micrometric silica thin films in transmission geometry. A Monte Carlo simulation method for the study of positronium

diffusion inside silica aerogel has been developed for this purpose. According to the simulation results the use of transmission geometry enhances the cold positronium yield in vacuum compared to the reflection geometry and the results will be used as indications for the design of thin film silica positron to positronium converters. In conclusion, besides acknowledging that the AEGIS experiment is ready to produce antihydrogen in order to measure antigravity, it has been shown that the positron annihilation techniques are suitable for the analysis of composition; porosities and voids of contemporary thin film based devices and allow disclosing new sets of information on them. Moreover, for fundamental antimatter physics experiments, the micrometric mesoporous silica membranes in transmission geometry will remarkably increase the efficiency in the production of cold positronium.

ULTRAFAST ELECTRON DYNAMICS IN THREE-DIMENSIONAL TOPOLOGICAL INSULATORS INVESTIGATED BY TIME- AND ANGLE-RESOLVED PHOTOEMISSION SPECTROSCOPY

Fabio Boschini - Supervisors: Claudia Dallera, Ettore Carpene

The topological insulating phase has been recently theorized and experimentally observed in three-dimensional systems. A metallic surface state with a Dirac cone dispersion like graphene appears within the bulk energy gap but, unlike graphene, spins and momentums are locked resembling an helical spin structure. The possibility to induce a spin-polarized surface current together with the predicted protection by spin-flip backscattering events promote the application of topological systems in future spintronic devices.

Angle-resolved photoemission spectroscopy (ARPES) is widely employed in studying surface properties of topological insulating systems. The understanding of physical properties of topological electrons under an optical excitation is fundamental for future applications and it can be achieved by exploiting the classical pump and probe technique. Time-resolved ARPES (TR-ARPES) provides a direct snapshot of the temporal evolution of the band structure of the system upon an intense optical perturbation. Only few research groups in the world can perform TR-ARPES experiments, thus dynamical properties of topological electrons are still partially hidden. In this

thesis an innovative TR-ARPES setup is described and novel experimental results on Bi_2Te_3 and Bi_2Se_3 topological insulators are presented.

Commonly, TR-ARPES setups are based on a high-repetition rate Ti:sapphire laser followed by a fourth-harmonic generation optical setup of its fundamental frequency (typically 1.55 eV). Our innovative setup is based on a high-repetition rate Yb-laser source. By means of a cascade of nonlinear processes 1.85-eV pump and 6.05-eV probe pulses are generated. The heart of the optical setup is a non-collinear optical parametric amplifier that allows to tune the output wavelength at 680 nm (1.85 eV) with an associated bandwidth ensuring a pulse duration shorter than 30 fs after the prism compressor. By a sum-frequency generation optical modulus 205-nm (6.05 eV) pulses are obtained. Emitted electrons are detected by means of a time-of-flight electron analyzer. The measured state-of-the-art 50-meV energy resolution together with the excellent 70-fs temporal resolution place our novel setup at the forefront of this technique.

Bi_2Te_3 and Bi_2Se_3 three-dimensional topological insulating samples were grown by the Prof. X. Zhou's research group at National Lab for Superconductivity Institute of

Physics (Beijing, China) and they present a single Dirac cone in the center of the Brillouin zone. We demonstrate the ability to modify the population of the topological Dirac cone of Bi_2Te_3 on a time scale of hundreds of femtoseconds. Our Bi_2Te_3 sample is p-doped, thus the Fermi level crosses the topological surface state. The pump beam promotes valence electrons into empty bulk bands. Hot non-thermal electrons redistribute in the whole Brillouin zone as a consequence of relaxation processes (mediated by electron-electron and electron-phonon scattering) and fill the empty states of the topological Dirac state. The population of the topological state presents a 70-fs delayed response time. This first experimental evidence of the delayed population time of the Dirac cone suggests that the topological surface state cannot be directly optically populated by the employed pump beam but only as a consequence of the electrons decay from the bulk bands. Hence, bulk bands behave as charge reservoirs for the topological state feeding this latter on a time scale of several picoseconds.

The Bi_2Se_3 sample is intrinsically n-doped, thus the Fermi level crosses the bulk conduction band and the topological Dirac cone is completely filled. A detailed study of pump induced

relaxation processes allows to extract the presence of a second empty Dirac-cone-like surface state approximately 1.8 eV above the first Dirac cone. The weak electron-phonon coupling of topological electrons leads to longer relaxation times in comparison to electrons lying in the close bulk band, allowing us to disentangle the topological state contribution from the bulk band one. The existence of the second topological surface state has been already proved by other research groups by means of two-photon photoemission technique. Theoretical calculations and the observed helical spin structure suggest that the second empty Dirac cone shares the same physical origin with the first topological surface state at the Fermi edge. We show novel dichroic TR-ARPES measurements of the second Dirac cone of Bi_2Se_3 where we are able to selectively populate one of the two opposite spin-polarized branches of the second topological surface state with circularly polarized pump light and follow the temporal dynamics of the dichroic signal, i.e. of the photo-induced spin-polarized electronic population. We detect a strong k-dependence of both the temporal decay and the response time of the dichroic signal. Thanks to an efficient bulk-to-surface state

optical transition, only empty states of the second Dirac cone away from the center of the probed k-region can be populated. Then, the spin-polarized electronic population decays along the spin-polarized branch of the second topological cone by intraband scattering events. Thus, a dichroic signal appears in the center of the second Dirac cone with a certain delay (approximately 30 fs) as a results of the intraband relaxation process. This is the first experimental evidence to our knowledge of the ultrafast flow of a spin-polarized electronic population in the second Dirac cone of Bi_2Se_3 . We prove the capability to selectively excite one of the two spin-polarized branches of the second topological state with circularly polarized pump light, i.e. photo-induce an ultrafast spin-polarized surface current. Moreover, topological electrons do not simply recombine with empty unpolarized bulk states but flow along the Dirac cone maintaining their spin-polarization. We observed an unexpected dichroic signal in correspondence with the image potential state of Bi_2Se_3 . The image potential state can be populated with the linearly polarized 6.05-eV beam and photoemitted with the circularly polarized 1.85-eV beam. The

revealed dichroic signal does not change sign in the whole probed k-region, contrary to what observed for the second surface state. This novel finding seems to indicate a net spin-order of the image potential state. The image potential state wavefunction is localized outside the sample but is presents also a decaying tail into the bulk. Thus, an interference effect between the image potential state wavefunction and the spin-polarized topological surface wavefunction is possible. This latter could lead the image potential state to earn a net spin-order. In conclusion, the excellent working parameters of our innovative TR-ARPES setup allowed us to obtain novel intriguing experimental results on the ultrafast electronic dynamics in three-dimensional topological insulating systems.

ADVANCED SPECTROSCOPY TECHNIQUES FOR THE STUDY OF PIGMENT MATERIALS

Anna Cesaratto - Supervisor: Prof. Gianluca Valentini

Conservation science is a multi-disciplinary field, which combines a number of scientific methods for the material characterization of works of art and of their degradation products, for the definition of proper conservation and preservation protocols, for the developing of new restoration materials. In particular, the characterization of the material used in an art object is fundamental not only for defining proper conservation protocols but also for the in depth study of the technology, the trade roots and the style of an epoch. Many advanced analytical tools have been recently developed, with the main aim of providing a chemical description of cultural heritage materials, with a non or micro-invasive approach. This is particularly challenging, due to the fact that artwork materials are complex mixtures intrinsically heterogeneous, composed of a wide range of compounds, from organic to inorganic ones, and a wide range of size scale, which goes from the chemical identification of compounds to the mapping of trace elements, alteration or restored phases. This intrinsic complexity calls for multi-analytical approaches, to overcome the various limitation of individual spectroscopic methods. This thesis reports the results

of the application of a set of advanced optical and vibrational spectroscopy techniques to the study of pigment materials. In particular, the attention has been focused on two different classes of materials: modern pigments and traditional dyestuff. As modern pigments, cadmium based pigments have been studied in depth; anthraquinone based colorants have been considered as traditional dyestuffs. Cadmium based pigments are cadmium-zinc sulphide ($Zn_{1-x}Cd_xS$ with $0 < x < 1$) or cadmium sulphoselenide (CdS_xSe_{1-x} with $0 < x < 1$), with a high substitution of Zn in the light yellow shades and a high substitution of Se in the darker shades. They are IIb-VIa semiconductor, with a direct radiative emission in the visible range and two trap state radiative emissions in the near IR. The in depth study of the photo luminescence (PL) emission of a group of commercially available cadmium based pigments gives new insights into the photophysical properties of these materials. The radiative emissions of the materials exhibited a strong dependence on the excitation power, as it can be seen in Figure 1, which shows the emission from a cadmium sample for two excitation regimes. In fact, a non-linear behaviour was demonstrated

by PL experiments at different irradiance, both in CW and with short pulses. Measurements have shown that the ratio between the band edge and the trap state emission intensity depends on the excitation intensity. These findings confirm that the mechanism for carrier recombination in cadmium pigments is highly influenced by electron trapping in deep trap states.

As regards traditional dyestuffs, a group of red anthraquinone based lake pigments and dyed textiles were studied, with both vibrational and electronic spectroscopy. Lake pigments and dyed textiles are produced through the formation of an insoluble dye-metal ion (called *mordant*) complex. Part of the research regarded the development and testing of a new Surface Enhanced Raman Spectroscopy (SERS) based technique. The approach combines the high sensitivity of the SERS read out with the high resolution of the UV-laser desorption of the materials in an area few microns large. The ablation step is described in figure 2: (i) a high power UV laser pulse is delivered on the area of analysis, (ii) the material enters in a plasma phase, (iii) the plasma plume expands upward and outward, (iv) the plasma solidifies on the SERS active substrate. After the ablation is

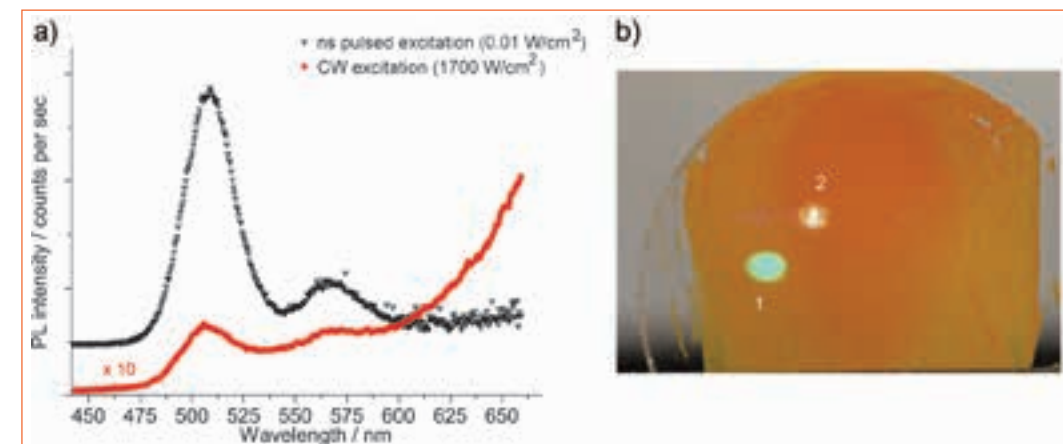

1. Photoluminescence spectra of a cadmium pigment sample following excitation with a 100 Hz-Q-switched and a CW laser source acquired with the spectrometer in continuous modality (a). Images of the PL emission excited in the pulsed (spot 1) and the CW (spot 2) regimes from the same sample (b).

performed in the selected area, the SERS spectra are acquired focusing a CW 488 nm laser directly on the SERS active substrate. The technique was successfully applied to the study of a series of painting cross sections, widely expanding the applicability of SERS based techniques to the study of single layer or single lake particles in cross sections or heterogeneous materials. The study of the same class of materials was then carried on with the application of steady state and time-resolved luminescence analyses on a series of anthraquinone dyed textiles, with the aim of discriminating between the various types of dye-metal ion complexes in a non-destructive fashion. In fact, the majority of the standard analytical technique

for dye analysis mainly focus on the detection of the organic part of the material, disregarding the metal ion used as mordant. In conclusion, a number of optical and vibrational spectroscopy techniques were merged together in a multi-analytical approach finalized to

the analysis of the palette of a watercolour painted by Vincent van Gogh. In particular, a novel data analysis protocol for the classification of multispectral data cube was combined with luminescence imaging techniques and with point-like Raman spectroscopy.

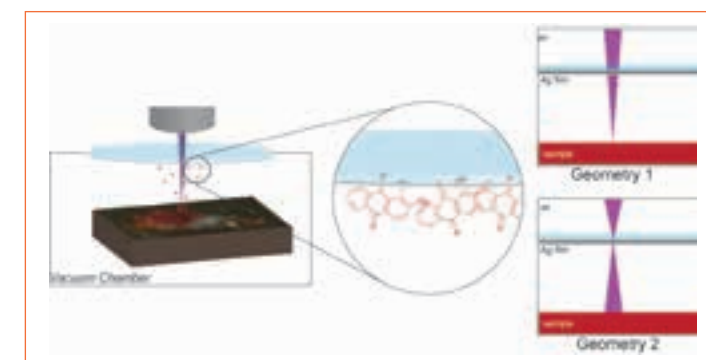

2. Schematic representation of the ablation step (left). Close up of the two ablation optical geometries: focussed beam (top) de-focussed beam (bottom).

INTEGRATED PHOTONIC CIRCUITS BY FEMTOSECOND LASER WRITING FOR QUBIT MANIPULATION, QUANTUM CRYPTOGRAPHY AND QUANTUM OPTICAL ANALOGIES

Giacomo Corrielli - Supervisor: Roberto Osellame

Quantum technology promises to revolutionize radically the way we look at information science, offering unprecedented levels of computation efficiency and communication security. In the past two decades, the effort of the scientific community for advancing in this research field has been enormous, from both the theoretical and the experimental point of view. However, despite the number of remarkable achievements in creating and manipulating individual quantum systems, quantum technology is still far from real world practical applications, due to the high complexity of the experiments, that makes them hardly scalable beyond the proof-of-principle demonstration level. A relatively new and effective approach for facing this huge technological challenge is that of integrated quantum photonics, where small, monolithic optical circuits are used to manipulate quantum states of light. The intrinsic mechanical stability of these devices allows to control the phase of light in each spatial mode to an extent that is impossible to reach with bulk optical elements, allowing for the fabrication of complex interferometric structures. The spatial overlap of different modes can be performed straightforwardly by means of directional couplers. The field

enhancement arising from the optical confinement in few-micrometer-sized waveguides improves the performances of non-linear interactions, for example for the realization of efficient integrated photon sources or frequency converters. Lastly, integrated optics, being a mature technology developed for classical optical communications, can benefit from a well-established manufacturing industry and a solid know-how in device designing. Among the various fabrication techniques, femtosecond laser micromachining demonstrated in the recent years to be a very powerful technology for the design and the development of innovative optical circuits for quantum applications. This technique, in fact, presents unique features and several advantages over conventional lithographic processes. It is a mask-less and single-step fabrication technique that does not need any special auxiliary facility, like a clean room. It can be performed with a relatively simple fabrication setup and this reflects in a significant cost reduction and speed-up in the prototyping of new devices design. Since the waveguide fabrication is based on non-linear multiphoton absorption of femtosecond laser pulses in a transparent

substrate, it is, at least at first approximation, independent from the specific chemical composition of the material. Consequently, femtosecond laser micromachining is adequate for processing a large number of different transparent substrates, from glasses and crystals to polymers, with the same laser system and fabrication setup. In addition, this technique shows an intrinsic three-dimensional fabrication capability, allowing for the realization of optical circuits with complex geometries, not obtainable with conventional lithographic processes. In this thesis work, femtosecond laser micromachining is used for the fabrication of several integrated optical devices that implement a number of new functionalities, with important applications in the field of integrated quantum photonics, in particular for the manipulation, the measurement and the transmission of qubits encoded in the polarization degree of freedom of quantum light. In addition, three experiments regarding the simulation in dielectric light-guiding structures of the dynamics of complex quantum systems are presented. For the first time, we realized a waveguide-based integrated device that behaves like an optical wave-plate, with

the optical axis inclined in a controlled and precise fashion. This new component permits to produce an arbitrary rotation of light polarization and paves the way to the full manipulation of light polarization in integrated optics. In order to demonstrate the immediate application of this novel element to quantum information science, and, in particular, to the manipulation of polarization encoded qubits, we fabricated an integrated device that performs the polarization state tomography of light, simultaneously on two separated spatial modes. We validated its functioning by performing the quantum state tomography of single photons and of polarization-entangled photon pairs. The high measured fidelities of the reconstructed states ($> 97\%$) are comparable to those obtainable with standard bulk optical elements and testify the suitability of our novel integrated components in the manipulation of polarization encoded qubits. A polarization insensitive integrated optical circuit lies at the heart of the functioning of the architecture we propose for short distance quantum communications. In particular, we have shown in this work the design of a handheld device based on micro-optics elements and with an extremely reduced footprint (few tens of mm^3) capable of preparing and sending over short distances faint laser pulses in four possible polarization states. An exhaustive characterization of all the single device components demonstrated that the sender module we propose is in principle suitable for performing quantum key

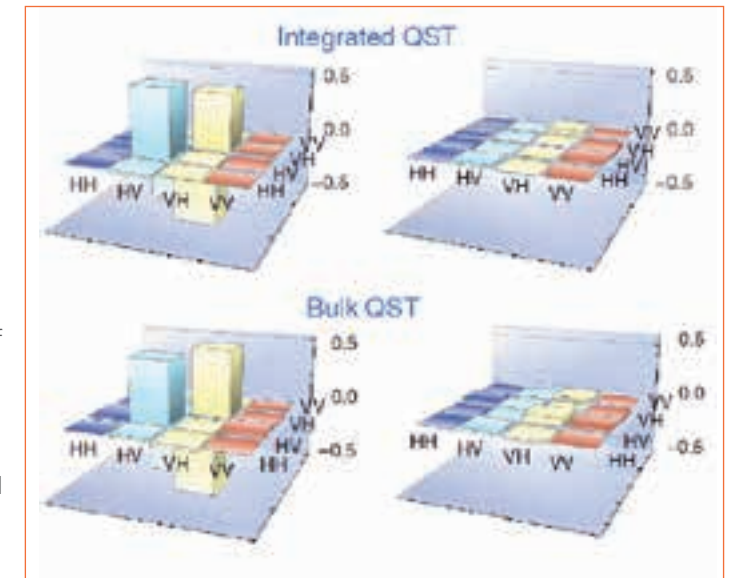

1. Real (left column) and imaginary (right column) parts of the density matrices of the Bell ψ^- state reconstructed with our integrated device (top row) and with standard bulk, optical waveplates (bottom row). The calculated fidelity between the two is $> 97\%$.

distribution protocols at high repetition rates (100 MHz), provided that the residual spectral distinguishability of the output photons is compensated. The presented results represent an important step forward in the realization of a customer-oriented quantum device with real world applications. Finally, we demonstrated how waveguide arrays, finely engineered both in terms of circuit geometry and waveguiding properties, can be used as model systems with controllable parameters to simulate, with only classical resources, the evolution of complex quantum dynamics that are inaccessible in real systems. By adopting this approach, we studied the effect of particles interaction on their motion in a ordered lattice, under the action of a static force, and we observed that under

suitable conditions, the exotic phenomenon of fractional Bloch Oscillations can take place. Furthermore, we studied how the presence of a strong AC monochromatic field can influence the electronic transport in a graphene-like bidimensional lattice and possibly induce dynamic localization. Finally, we constructed a specially engineered semi-infinite lattice that is capable to support a peculiar surface state, with the energy embedded in the continuous band of scattered lattice states, showing an algebraic rather than exponential localization at the lattice edge.

“TIME DOMAIN DIFFUSE OPTICAL IMAGING AT SHORT SOURCE-DETECTOR DISTANCE”

Laura Di Sieno - Supervisor: Antonio Pifferi - Assistant supervisor: Alberto Dalla Mora

The research leading to this PhD dissertation has been mainly accomplished in the Physics Department of Politecnico di Milano and in collaboration with foreign institutions as Commissariat à l'Énergie Atomique et aux Énergies Alternatives (CEA, France) and Physikalisch-Technische Bundesanstalt (PTB, Germany). The main framework of this work resides in the interaction of light with diffusive media. In the last decades light has become attractive as a non-invasive tool to investigate diffusive media and different optical methods based on Continuous Wave (CW), Frequency-Domain (FD) or Time-Resolved (TR) approaches have been developed. Although CW techniques are more common, easy to implement and already commercialized, TR spectroscopic techniques are important alternatives for non-standard cutting-edge research. The most important feature of the TR approach is that the depth investigated by photons is encoded in time. Indeed, the early-arriving photons are those that travelled only in the superficial layer of the medium while photons arriving later have visited deeper structures. Recently, it has been demonstrated that the use of a small distance (few mm, or even null) between the injection and collection points improves

the confinement of photons within the probed medium. This feature provides a better contrast, spatial resolution and signal intensity as compared to measurements at a large interfiber distance in the case of reflectance geometry. However, the huge increase in the peak of “early photons” (i.e. photons directly reflected or scarcely diffused from the surface) causes the saturation of the dynamic range (DR) of common single-photon detectors thus preventing the use of the null-distance approach. For this reason, the technical implementation of a null-distance deep-tissue scheme is very challenging and never tried before outside our research group. The null-distance approach has become feasible for the first time thanks to the development by “Dipartimento di Elettronica, Informazione e Bioingegneria” of Politecnico di Milano of the Single-Photon Avalanche Diode (SPAD) modules that can be enabled in fast-gated mode. Indeed, they can switch from the OFF to the ON state in less than 200 ps, thus rejecting the peak of early photons. In addition, the application of the gated technique permits to enhance the DR of the measurements up to 7 orders of magnitude. My PhD activity was completely devoted to the investigation

of the physics at the null-distance its experimental use in different application fields such as functional Near-Infrared Spectroscopy (fNIRS) for brain imaging, non-contact scanning imaging and tomographic reconstructions. First of all, we aim to demonstrate that the use of the null-distance approach, coupled with the high DR fast-gated acquisitions, can improve fNIRS measurements and permits to detect brain activation with higher signal-to-noise ratio and improved spatial resolution. Different technological solutions were considered to solve problems connected to high DR acquisitions (e.g. the removal of any optical reflection) and a dedicated setup was built. Finger tapping exercises on healthy subjects were performed and we clearly demonstrated the improvement given by the null-distance approach in the detection of brain activation. The technological development of compact detectors and microelectronic laser sources (e.g. VCSEL), will improve the proposed setup, decreasing cost and going towards a miniaturization of the probe. A second field of application explored during my PhD is the non-contact scanning imaging. A non-contact approach is needed in cases where the contact between

optode and tissue can cause pain (e.g. burnt injuries) and even perturb the system (e.g. local variation of blood content due to compression of skin necessary to achieve good optical contact). Also, remote scanning of the forehead for e.g. cognitive studies is another interesting perspective. For all those reasons, a non-contact TR scanning instrument based on null-distance was built. The proposed setup was characterized in terms of performances using two protocols for assessment of time-domain diffuse imagers (BIP and nEUROpt protocol) agreed upon by many institutions. After the objective characterization of the instrument, several *in-vivo* measurements on healthy volunteers were performed. In most of them, the expected trend of oxy- and deoxy-haemoglobin was observed, meaning that the proposed instrument is able to detect hemodynamic changes. During my PhD I also investigated the use of a null-distance approach for tomographic reconstructions. In this case, the high DR acquisitions were analysed using the Mellin-Laplace transform which exploits the different arrival time of photons to improve the reconstruction. We demonstrated on phantoms that the new approach permits to increase the spatial resolution and the depth sensitivity of both 2D and 3D reconstructed maps (see Fig.1). Then we moved toward clinical applications such as the monitoring of the vessel permeability in flap surgery. We built an instrument based on multiple source-detector

pre-clinical tests on rats. We demonstrated that the proposed setup is able to follow the hemodynamic variations that can occur in case of complications of flap surgery (e.g. formation of a thrombus). Further experiments on model closer to human (e.g. piglets) are currently under study. The use of the null-distance approach, coupled with high DR fast-gated measurements, enlightens the potentialities of this technique, but also allows us to understand the bottleneck of the technology. The increase in the DR of the measurement is indeed limited by a source of noise called “memory effect”. In order to better understand this newly discovered background contribution, a comprehensive characterization was done to identify its physical origin. A possible solution for the reduction of the “memory effect” by 4 decades was then proposed. During my PhD I finally

investigated the possibility to replace the Time-Correlated Single-Photon Counting (TCSPC) board with a dual window fast-gated counter. Indeed, fast-gated counters can dramatically reduce both costs and complexity in TR multichannel systems, while achieving high count rate, thus offering a great advantage in applications like brain and muscle functional imaging. We proved the equivalence between a classical TCSPC board and a fast-gated counter in terms of achievable contrast and we demonstrated its suitability for various applications. In conclusion, the improvement given by the null-distance approach in different applications was demonstrated. In the future, the development of compact and low-cost devices can lead to the realisation of small and portable instruments, exploiting the null-distance approach in different applications fields.

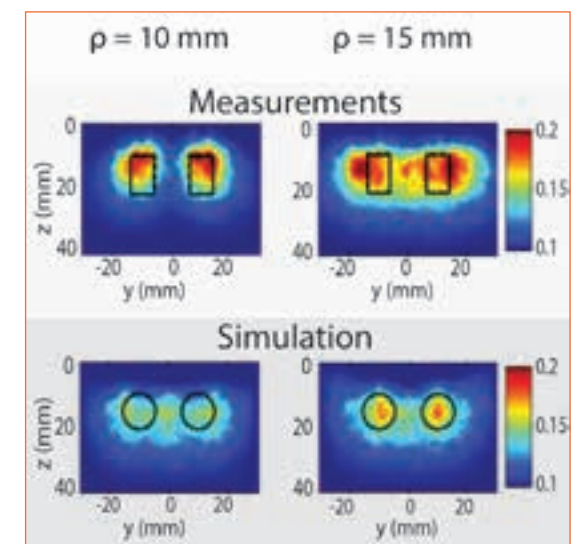

1. Reconstructed (first row) and simulated (second row) maps of two separate inclusions at 15 mm depth. The black signs represent their real position.

TRIPLET–TRIPLET ANNIHILATION-INDUCED PHOTON UP-CONVERTED DELAYED LUMINESCENCE IN SOLID-STATE ORGANIC COMPOSITE

Hossein Goudarzi - Supervisor: Prof. Panagiotis E. Keivanidis

Herein we will present results of our studies on photoactive layers of solution-processed organic composites that could be potentially utilized as solid-state photon up-converting layers. Different methodologies for increasing the luminescence intensity of the triplet-fusion induced photon up-conversion process in solid state layers of organic thin films will be discussed. In this work, low-energy photon up-conversion on the basis of charge transfer (CT-UC) and of energy transfer (ET-UC) in thin films will be probed as two possible mechanisms of low-energy photon up-conversion via triplet-triplet annihilation (TTA-UC). Regarding the ET-UC process, a comprehensive temperature-dependent spectroscopic study will be carried out on a binary composites consisting of the organometallic complex (2,3,7,8,12,13,17,18-octaethyl porphyrin) platinum (II) (PtOEP) mixed with the blue emitter 9,10 diphenylanthracene (DPA). Time-integrated and time-gated (on the ns- μ s time scale) photoluminescence (PL) measurements will be employed for probing the generation of the photon up-converted DPA delayed luminescence via TTA-UC, after the laser photoexcitation of DPA:PtOEP at 532 nm. In the light of these data as well as atomic force

microscopy (AFM) imaging, it will be demonstrated that the up-converted blue emission will be significantly enhanced, if the binary model is dispersed in the photophysically inert matrix of poly (styrene) (PS). The ternary structure PS:DPA:PtOEP will experimentally prove that the presence of PS tunes DPA and PtOEP aggregation and consequently gives rise to an increased up-converted luminescence emission. Concerning the CT-UP process, the same photophysical characterisation will be accomplished on the blend films comprising PtOEP as the sensitizer and either PF2/6 or PF8 as the blue emitter. The experimental observation from the comparative room-temperature PL measurements will confirm that the up-converted TTA-induced blue emission intensity will be enhanced in PF8:PtOEP thin film in respect to PF2/6:PtOEP. Moreover, the effect of β -phase formation in the film of PF8:PtOEP will be addressed. The time-integrated and time-gated PL measurements will rationalize that the presence of β -phase in the up-converting composites affects the intensity and the lifetime of the up-converted blue emission. The temperature-dependent PL measurements on the aforementioned up-converting

composites will help us to gain insight about the influence of temperature on the CT-UC and ET-UC processes. According to the time-integrated PL studies in the range of temperature between 100 K and 290 K, it will be verified that lowering the temperature enhances the TTA-induced up-converted blue emission intensity in the up-converting composites working with either CT-UC process or ET-UC process. At present, our results enable a discussion on the microscopic processes of energy migration that dictates the efficiency of TTA-induced low-energy photon up-conversion in solid-state composites. This methodology paves the way toward the sensitization of photoactive devices such as solar cells, light sensing photodiodes, and photodetecting transistors to photons of low energies.

HYBRID SOLAR CELLS: EFFICIENCY, STABILITY AND PROCESSABILITY

Simone S. Guarnera – Supervisor: Dr. Annamaria Petrozza

The work introduced here was carried out in the laboratories of the Center for Nano Science and Technology (Istituto Italiano di Tecnologia) in Milan and of the Department of Physics of the University of Oxford.

Photovoltaics (PV) is considered one of the most promising renewable energy technologies that could help to solve important environmental and geopolitical problems arising from the actual consumption of fossil fuels. Because of the remarkable potential of a technology based on an energy source worldwide available, in the last decades research and technology innovation has focused on the development of solar cells able to achieve high power conversion efficiencies with low production costs. Among these, hybrid devices, such as dye-sensitized, polymer/metal oxide and perovskite-based solar cells, have been the subject of intense research. However, since the PV market needs efficient and stable solar cells that can be prepared with cheap and simple processing techniques, as long as the focus of the research is just on one of these research fields, the route towards the commercialization of the technology will be long. In particular, the long term stability of third-generation solar cells has drawn little attention

even though it is an important issue that will determine whether they can represent a market opportunity.

The research activity presented in the PhD thesis deals with the design and the development of innovative hybrid solar cell architectures, i.e. devices incorporating both organic and inorganic materials. In order to improve the devices on its whole, we concentrated our efforts mainly on the improvement of long-term stability while keeping an eye on efficiency and processability. Dealing with hybrid active materials, vulnerability towards moisture is critical. Therefore we present technological solutions that have been conceived to improve the stability during long-term operation or during the fabrication process of dye-sensitized solar cells (DSSC) and perovskite solar cells (PSC). We approached the problem of water infiltration in a DSSC by engineering the device architecture to fabricate more robust cell, independently of the quality of the encapsulation. We introduced for the first time the concept of an integrated getter in an optoelectronic device and we implemented that by introducing the getters in the form of a dispersion of nanozeolites in the mesoporous TiO₂ photoanode of the solar

cell. Thanks to the capability of the nanozeolites to absorb water, we have demonstrated an improved stability of the devices after 1000 h of outdoor exposure without affecting the performance of the device and not even the standard fabrication process.

We showed that the concept of integrated getter can be successfully implemented in a PSC, as well.

Since hybrid organometal halide perovskites are very sensitive to moisture during the crystallization process, usually they are processed in a controlled dry atmosphere. To improve the robustness of PSCs, we redesigned the architecture of a standard cell by replacing the mesoporous Al₂O₃ scaffold layer with a scaffold composed of nanozeolites. We demonstrated that standard devices show lower photocurrent when they are fabricated in a humid environment, while the performances of device with the nanozeolites scaffold are independent on the environment of the processing. Therefore, we proved that the zeolite scaffold can protect the device during the fabrication process. Another common issue of perovskite solar cells is the initial drop in efficiency that is observed during long term stability studies. We

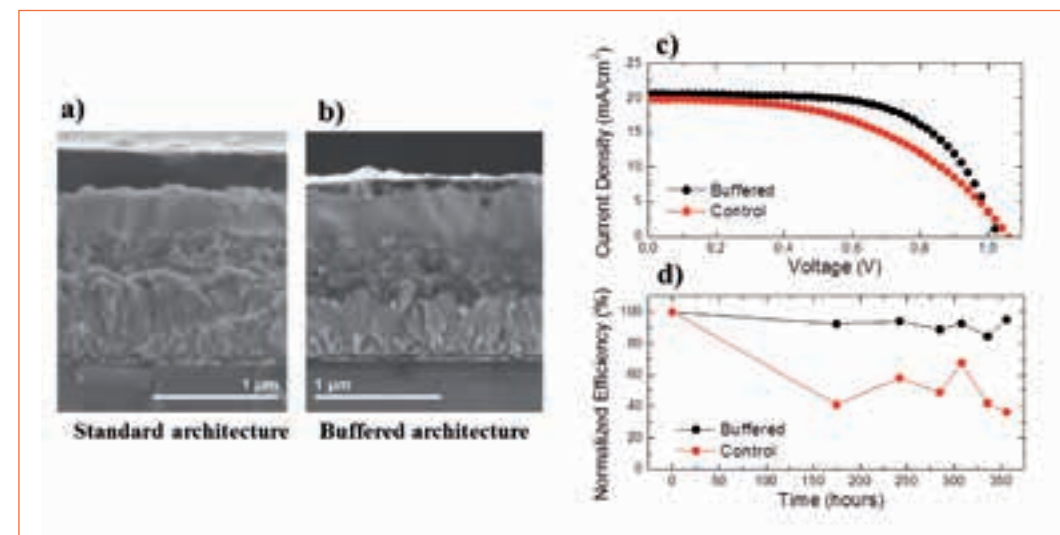

1. SEM pictures of (a) standard PSC architecture and (b) new architecture with a protective active layer. (c) J-V curve of devices with (black spot) and without (red spot) buffer layer. (d) stability test of previous devices.

first identified the origin of this efficiency drop with the occurrence of electrical shunt pathways becoming increasingly more important as the device is operated under standard working conditions. We developed an equivalent circuit model, to quantify the loss of current that results from the undesirable leakage path that arise as a consequence of the migration of the metal through the hole-transporting material (HTM). Then we proposed a new device architecture which is able to address this problem (Fig. 1a,b). By adding a thin Al₂O₃ mesoporous layer between the perovskite and the HTM, we prepared devices with nearly no degradation in the first 350 hours of operation (Fig 1d). Moreover, we improved the efficiency of such devices by reducing the high series resistances related to the thickness of the HTM (Fig 1c). Finally, we focussed on the

improvement of hybrid polymer/metal oxide solar cells, a technology with big potentiality, thanks to the non-toxicity of the materials and the low-cost of the manufacturing process. Important improvements have to be done to increase the power conversion efficiency to levels appealing to the PV market. The understanding of the effect of local morphology on charge generation dynamics at hybrid polymer/metal oxide interfaces represents a matter of primary importance on the way to enhance device performance. We found out that it is possible to tune the interfacial polymer morphology by properly treating its surface. In particular, we measured a higher charge injection efficiency in the oxide from amorphous polymer phases compared to crystalline phases. Nevertheless, we found that the energy mismatch existing between the two phases acts as a barrier to charge collection, then devices with a large

amount of crystalline phases perform better despite the lower injection efficiency in the metal oxide. This has been proven by growing a monolayer of 4-mercaptopyridine on the metal oxide surface. This interlayer promotes a better covering of the TiO₂ surface and a π - π stacking of the polymer already at the interface, allowing for an enhancement by three times of the device efficiency.

DEVELOPMENT OF GRAPHENE-BASED INTEGRATED CIRCUITS FOR RADIO-FREQUENCY APPLICATIONS

Erica Guerriero - Supervisor: Prof. Roman Sordan

The microelectronic scenario is following a constant trend toward miniaturization, beneficial for increased operation speed and lower fabrication costs. However, the conventional silicon-based electronics is reaching a scaling physical limit, with short channel effects becoming detrimental for devices operations. In this perspective the scientific community has intensified the research on novel materials, among which graphene, a two dimensional sheet of carbon atoms arranged in hexagonal lattice, emerged as one of the most promising candidates. The high mobility (almost equal between holes and electrons), carrier density and saturation velocity arising from the peculiar band structure make graphene suitable for high speed electronics. However, the lack of a bandgap prevents graphene-transistors (GFETs) to be turned off, with consecutively low I_{ON}/I_{OFF} and high static power consumption, hindering the development of graphene-based devices for logic applications. In the field of high-frequency analog electronics, however, the complete switching-off of GFETs is not required, thus making graphene an attractive option. This PhD work was devoted to the development of graphene devices for high-frequency applications. Since almost all

real circuits comprise multiple stages, GFETs exhibiting intrinsic gain $A_V = g_m r_d > 1$ are needed to provide voltage gain to the single stage, preserving signal integrity in transmission. To achieve over-unity gain a low output resistance r_d and high transconductance g_m are needed. With a high- κ , ultra-thin native aluminum oxide formed during e-beam evaporation of Al, we managed to fabricate GFETs with high g_m and A_V . Connecting these GFETs in inverter configuration we demonstrated the first graphene voltage amplifiers exhibiting significant voltage gain in ambient conditions. Graphene obtained by CVD-growth have been implemented in the fabrication process, providing more homogeneous performances and scalability, and CVD-graphene-based inverters exhibiting DC and AC voltage gain above 20 dB were demonstrated. These devices could be cascaded to perform multiple logic operations. Demonstration of device cascading led to the fabrication of the first graphene integrated ring oscillators (ROs), Fig. 1a,b. ROs are composed of an odd number of inverters cascaded in a loop in which noise components at a certain frequency can propagate and get amplified thereby inducing oscillation. ROs require inverters with over-unity voltage gain,

in/out signal matching, large voltage swing, and high current drive. Knowing the effect of device parameters on performances we have tried to optimize the design to reduce the delay per stage. Different metals have been tested with two-probe and four probe measurements to reduce contact resistance, showing that pure Au contacts provide the lowest value of $200 \Omega \mu\text{m}$. Best devices exhibit a highest oscillation frequency of 4.3 GHz with $0.9 \mu\text{m}$ gate length, surpassing silicon ROs speed at the same gate length, Fig. 1c. The fabricated ROs have been tested as analog mixers and amplitude modulators, operating in the gigahertz frequency range, thereby demonstrating the potential of this technology for integrated circuits applications. The second part of my PhD work has dealt with the study of GFET high-frequency response, aiming to further improve the performances and to extend their frequency capability. A FET can be described as a two-port device, with gate as input and drain as output port. The frequency response can be probed through the application of a small power wave signal superposed to the DC bias at the highest gain point at both ports. A VNA records the reflection and transmission coefficients of the power waves, called

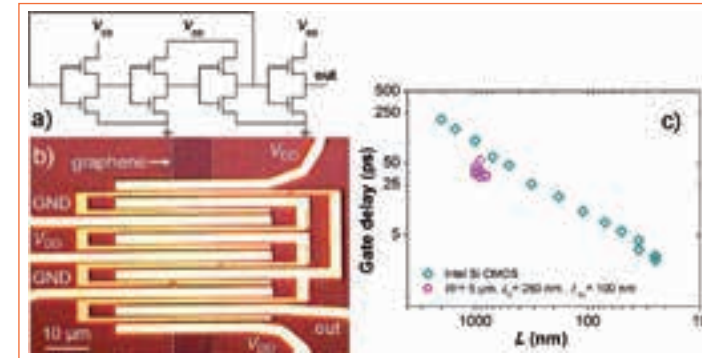

1. a) Circuit schematic and b) optical image of the fabricated RO. c) Gate delay per stage: comparison between current Si CMOS technology and the best graphene ROs fabricated.

S-parameters, that are related to the impedances of the circuit. To extract useful information from measurements I have made a small-signal model which contains all the resistances, capacitances and inductances of the circuit, Fig. 2a. With ADS software, the values of these parameters can be optimized relatively to the measurements, giving access to the intrinsic device parameters. From S-parameters measurements the maximum oscillation frequency f_{max} , cutoff frequency f_T and A_V can also be extracted. f_T gives an estimation of the transit speed of the carrier in the channel, while f_{max} describes the maximum frequency at which the transistor is capable to amplify power. Typically in GFETs f_T is higher than f_{max} in contrast with conventional

HEMTs. However, in our devices we found out the opposite trend that can be explained by the large r_d (good saturation) shown by GFETs thanks to the ultra thin oxide that leads a strong gate control producing a fast carrier depletion. The GFETs exhibit highest f_T of about 10 GHz, f_{max} of 21 GHz, Fig. 2b, and $A_V > 30$ dB at 10 MHz for devices with $1 \mu\text{m}$ gate length. Moreover the f_{max}/f_T ratio is above 3, the highest value ever reported for GFETs. Compared with the state of the art of graphene technology these devices exhibit good A_V and f_{max} while f_T is still limited by the low intrinsic mobility, mainly due to the oxide interfacial traps that degrades transport properties increasing the scattering. To improve the performances we should improve the quality of

oxide and reduce the contact resistance. We foresee that it would be difficult to outperform the III-V in a short term. Anyway graphene has shown speed performances that are unbeated by organic electronics on every substrate, so we can guess that this performances can be obtained as well on flexible and transparent substrates through further research.

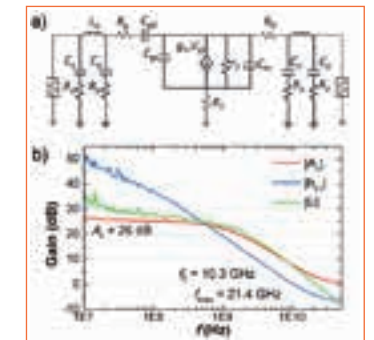

2. a) Small-signal circuit model of the GFET used to extract device parameters from S-parameter measurements. b) Gain performance f_{max} , f_T and A_V for one of the GFETs.

ULTRAFAST MAGNETO-OPTIC SPECTROSCOPIC ELLIPSOMETRY: GENUINE MAGNETIZATION DYNAMICS IN HALF-METALLIC AND METALLIC SYSTEMS UPON LASER EXCITATION

Hamoon Hedayat Zadeh Roodsari - Supervisors: Ettore Carpene, Claudia Dallera

Ultrafast optical techniques have been established as the most effective and flexible approaches to study the dynamics in a material within a picosecond time-window. This relatively new field provided fundamental insight into one of the most important properties of condensed matter systems: magnetism. Magnetism, a primary physical phenomena, has been recognized thousands of years ago as its trace is found in Chinese and Greek ancient references. During this long time, magnetism, even without a deep and fundamental understanding, has been employed in several applications, e.g. compass needle. About two hundred years ago, Oersted realized that the interaction between the electric field and a magnet could have unlocked the gate to dramatic technological applications, including electric motors. Later, Faraday discovered the rotation of light polarization when passing through a magnetic medium, followed by Kerr in 1876, who put the first stones in a new branch of magnetism called magneto-optics. The next milestone in the field of magnetization is due to Maxwell and his basic equations, which mathematically systematized the relation between magnetic field, electric field and charges and currents. Nevertheless, a

while later, it was proposed that magnetization is a quantum-mechanical concept, so, until quantum mechanics gradually evolved within the last century, magnetization remained a rather unclear phenomenon. Latest decades were full of significant progress in the understanding and application of magnetism theoretically and experimentally. Parallel to the rapidly expanding computer industry, demand has grown for faster data access in the memory storages. One of the potential candidates for this continuing quest has been *photonic* control of the spins in a suitable magnetic material. Owing to technical innovations in the optical apparatuses, leading to generation of beams with only few femtosecond (10^{-15} s) pulse duration, the investigation of magnetic properties on such a short time scale has become possible, in particular with *pump & probe* technique. The *pump & probe* scheme can be basically described in the following general picture: an ultrafast intense laser pulse, the pump, locally perturbs various (quasi-) particles in a sample. Then after a certain delay (which in our experiments could range from tens of fs to tens of nanoseconds), another ultrashort pulse, sufficiently weak and with a specified polarization, the so-called probe,

monitors the modifications of interest in the heated region. By employing the *pump & probe* method, and based on changes in the polarization state of the reflected probe beam from a magnetic specimen, we can elucidate spin variations: the technique is called Time Resolved Magneto Optical Kerr Effect (TR-MOKE) and is a well-established method to extract the dynamics of magnetization down to the fs time domain. Although deliberate manipulation of spins in the fs time window may not bring to femto-spintronics devices in the near future, the extensive scientific curiosity in this fields yields more illuminating insight about the fundamental characteristics of the photon-matter interactions and the magnetization behavior in the strongly nonequilibrium state. The principal objective of our study has been a comprehensive investigation of the ultrafast spin dynamics in the metallic ferromagnets by means of time resolved magneto optical Kerr effect technique. In these transition metals, the spin quenching process takes place within only few hundreds of fs upon laser excitation: the most rapid magnetization variation ever observed. The origin of this ultrafast phenomena is under vigorous debate. A number of microscopic models have been

suggested for the mechanism, along the progress on the experimental side. Some of the theories are more accepted, but up to date there is not a unanimous agreement. The theories can be categorized into two general types: single particle based and collective excitations based mechanisms. Our recent experimental evidences contribute to further clarification of the process.

A crucial point is that in particular conditions TR-MOKE does not reflect the pure *magnetic* behavior, i.e. it contains mixed information about charge and spin effects. We have developed an experimental approach, so-called Time Resolved Magneto-Optic Spectroscopic Ellipsometry (TR-MOSE), to carefully analyze the Kerr signal. Utilizing this method we are well able to disentangle magnetic contributions from optical effects. We have successfully performed TR-MOSE in several metallic and half metallic systems, and their genuine spin dynamics has been deduced and discussed in great detail.

The experiments to study the ultrafast demagnetization dynamics in ferromagnetic metals have been conducted on a 50 nm thick Fe (100) film epitaxially grown on MgO (100) at room temperature in ultrahigh vacuum. The results revealed

the time scales of different (quasi-) particle interactions after the pump excitation: electron-electron interaction occurs on a time scale of 100 fs, demagnetization is found to take place on 180 fs timescale and the extracted time constant for electron-phonon relaxation is 260 ps. The deduced dynamics of the conductivity tensor demonstrates that ultrafast demagnetization cannot be attributed to significant modifications of the band structure, such as a collapsing exchange interaction (related to single particle processes). Instead we suggest that the loss of spin ordering takes place due to *electron-magnon* interaction (collective excitation). Our proposed picture is perfectly consistent with the experimentally obtained time-scales, energy cost and the observed fact that shows that demagnetization is probe energy-independent. In order to clarify whether TR-MOKE technique reliably traces the spin dynamics or not, we have also compared the magneto optical response of some ferromagnetic benchmarks: metallic Fe and halfmetallic CrO₂ and La_{0.7}Sr_{0.3}MnO₃ (LSMO) systems. Half metals are a category of ferromagnetic or ferrimagnetic materials whose electronic structure

shows unusual properties about the Fermi level: for one spin orientation they have conducting metallic behavior, while for the opposite spin orientation the presence of a gap in the density of states leads to semiconducting or insulating properties. We measured the TR-reflectivity for all samples in the same delay range. Our analysis suggests that a drastic change in the transient reflectivity can be regarded as a clear hint of charge contributions in the Kerr signal. In the case of CrO₂ an order of magnitude larger jump in the initial reflectivity with respect to Fe sample can be observed, corresponding to considerable charge effects in the Kerr signal for the half metallic sample. Since we found an unusual probe energy-dependence results of the transient magnetization behavior in LSMO sample, we plan to perform the same experiments in different LSMO stoichiometries as a next step to reveal the genuine spin behavior in these interesting and complex oxides.

STUDY OF TRIPLE BULK HETEROJUNCTION ORGANIC SOLAR CELLS

Zhipeng Kan - Supervisor: Dr. Panagiotis E. Kevanidis

Organic materials offer an attractive opportunity for the development of organic photovoltaic cells that could support portable consumer electronics. With respect to the state of the art, organic photovoltaic cells (OPV) show low values of power conversion efficiency (PCE) not so attractive for industrial production. Different approaches to improve the PCE were reported in literatures, and one of these was by acting on the morphology of the mostly used active layer based on the binary blend of P3HT: PCBM, for example through the introduction of solvent additives and/or a third component. The addition of a third component could extend the absorption band of the binary cells, since the

organic materials could cover the low-energy range of the solar spectrum. The use of ternary blend as the active layer has been also suggested as a practical method for controlling the morphology of the OPV layer. Considering the ternary organic solar cells progresses, a methodology for improving the PCE of organic solar cells made by photoactive layers of P3HT and PCBM of non-optimized microstructure is presented, through the introduction of a quinoidal small molecule 5,5'-bis-(3,5-di-tert-butyl-4-oxo-2,5-cyclohexadiene-1-ylidene)-2,2'-dihydroxy bithiophene (QBT) as a third component. Based on a series of independent characterization experiments we address the QBT content

dependent photophysical, electrical, thermal, structural and morphology-related properties of the ternary photovoltaic P3HT: PCBM: QBT system for elucidating the origin of the PCE improvement. An increase in efficiency around 47%, by adding only 0.6wt% of QBT, has been actually gained, while further additions are detrimental for the device performances. It was highlighted that in the P3HT: PCBM: QBT systems charge generation proceeds via three different excited state pathways that are consistent with the relative position of energy levels of the materials involved. The direct excitation of the P3HT component results in charge generation that is driven by electron transfer between the photoexcited P3HT and both the electron acceptors QBT and PCBM in the triple bulk heterojunction (BHJ). Then, the direct excitation of PCBM causes energy transfer from the photoexcited PCBM to QBT followed by a hole transfer process from QBT to P3HT. Moreover, the direct excitation of QBT, which is characterized by an absorption at the wavelength range of 700 nm, results in photocurrent generation via a photoinduced hole transfer from QBT to P3HT. The positive impact of these three excited state path ways on the production of photocurrent is confirmed by

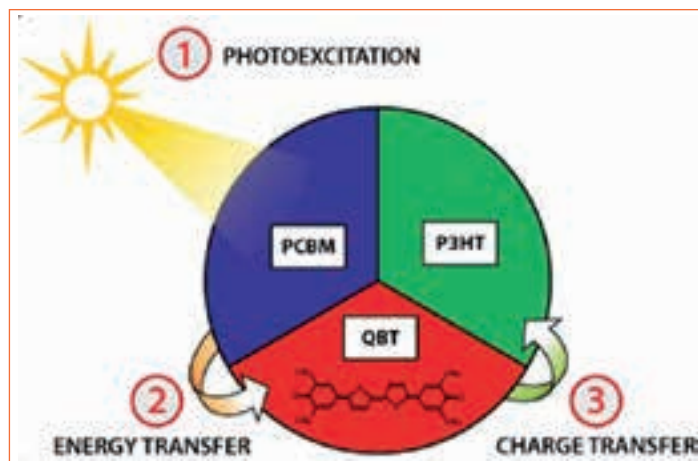

1. Graphic abstract

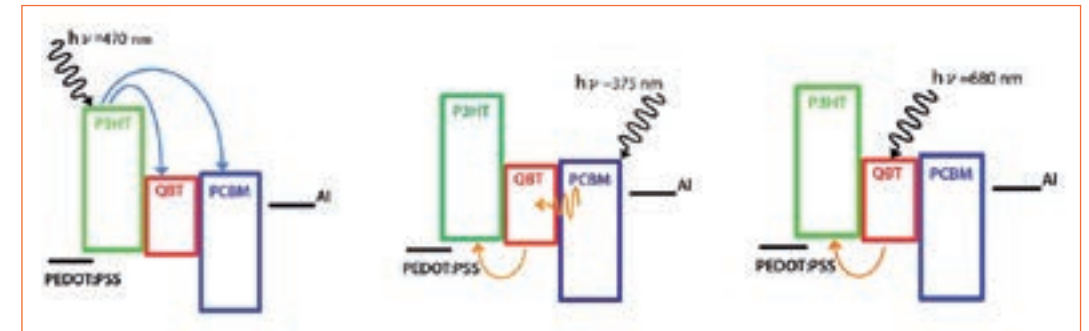

2. Sketch of ternary blend energetics and proposed excited state pathways. Schematic representation of the energy levels of P3HT, PCBM, QBT, as obtained by cyclic voltammetry. The LUMO P3HT is taken as -2.9 eV.

the EQE spectra of the ternary devices that show improved EQE values at the corresponding wavelength ranges. Then the effects of donor polymer molecular weight on ternary organic solar cells properties were investigated. Two sets of P3HT: PCBM: QBT system, which show P3HT characterized by different

molecular weight, were studied by comparing the electrical properties, surface topography, film crystallinity and charge carriers mobility. The results turned out that with QBT as the third component, the h-P3HT (h: high molecular weight) matrix crystallinity was improved, assisting to an enhanced absorption, increased

holes carriers mobility. As a comparison, QBT did not have positive effects on I-P3HT: PCBM: QBT (I: low molecular weight) properties, because the crystallinity level of I-P3HT matrix is already optimized. The microstructures of the active layer determines the triple bulk heterojunction devices performances.

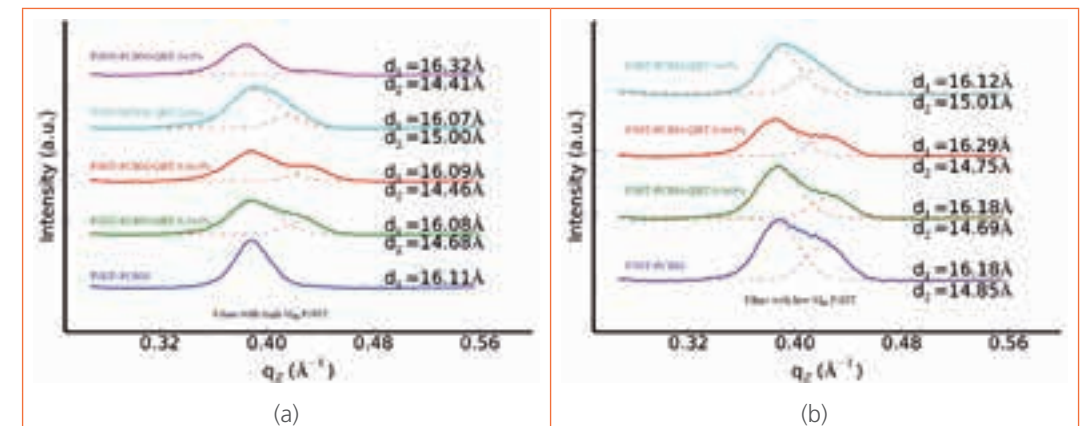

3. Ternary blend films crystallinity summary. (a) h-P3HT-PCBM-QBT films, (b) I-P3HT-PCBM-QBT films

FABRICATION AND CHARACTERIZATION OF POLYMER- BASED ARTIFICIAL RETINAL PROSTHESIS

Lucia Laudato - Supervisor: Dr. Maria Rosa Antognazza

In the expanding research field of bioelectronics, optical stimulation of living cells and tissues has recently started to emerge as a promising tool, complementary to electrical stimulation, both for *in vitro* and *in vivo* studies. The most direct application falls within the field of retinal prostheses, consisting in restoration of impaired light sensitivity in blind retinas. In this scenario, organic materials appear optimal candidates for active photosensitive layers and/or conducting electrodes and/or substrates, thanks to their excellent biocompatibility, mechanical properties and optoelectronic capabilities. It was recently reported that polythiophene-based blends are able to elicit action potential in primary neuronal networks, and also to partially restore light sensitivity in explanted retinas bearing photoreceptors degeneration. These promising results encouraged the realization and functional evaluation of an all-organic, photovoltaic retinal prosthesis. Respect to the current, state of the art retinal prostheses based on inorganic materials, a photovoltaic prosthesis realized with an organic semiconductor avoids use of external components (like intraocular receivers and amplifiers) and does not need any wiring, can offer

enhanced spatial resolution, better biocompatibility and higher conformability to the remaining retinal tissue. Moreover, organic conductors and semiconductors are unique materials in combining ionic and electronic conduction, thus mimicking the mechanisms adopted by nature for signal transmission. Besides the above mentioned benefits, the contact of an organic semiconductor with tissues and physiological solutions rises important issues of biocompatibility and temporal stability. In the first part of this thesis, the hybrid interface of an organic semiconductor with a physiological-like environment has been widely characterized by making recourse to a plethora of optical and electronic techniques, and by adopting the preferential architecture of a photoelectrochemical cell (PEC). Interestingly, transient photocurrent measurements have permitted to identify the main processes occurring at the interface of the polythiophene derivative with aqueous solution under irradiation. The PEC cell has been studied also in case of oxidation of the polythiophene based film by treatment with oxygen plasma: this case resembles the one of sterilization, and suggests that, if performed with optimized parameters, oxidation doesn't

affect the PEC cell efficiency in photo-current generation. All organic, photovoltaic retinal prosthesis has been then optimized and widely characterized. Preferred device architecture includes a fully biocompatible and flexible substrate, namely a silk fibroin film, a biocompatible and flexible conducting layer, namely a poly(3,4-ethylenedioxythiophene) and poly(styrenesulphonate) (PEDOT:PSS) film, and an active, conjugated polymer layer, namely a regioregular poly(3-hexylthiophene) (rr-P3HT) film. The prosthesis has been analyzed after 28 days of immersion in saline solution, irradiation with ambient light at 37 °C, by means of absorption spectroscopy, contact angle and transient photocurrent measurements. The prosthesis stability in physiological conditions has been therefore successfully assessed. Realized prostheses have been implanted in dystrophic Royal College of Surgeons (RCS) rats' eyes, and biocompatibility and functionality studies have been carried out. Optical coherence tomography, confocal scanning laser ophthalmoscopy, histochemistry and immunohistochemistry, electrophysiology, pupillary reflex measurement, and visually driven behavior test have been

performed. It has been observed that organic prosthesis can sustain the surgical procedure for subretinal implantation and follows the natural curvature of the rat retina. Biocompatibility properties have been assessed as well. Preliminary results indicate that, up to two months post implantation, light sensitivity of dystrophic retinas is restored by the photovoltaic prosthesis; moreover, they show that its implantation doesn't compromise the functionality of remaining inner retinal layers. Based on these promising results, the feasibility of implantation of an all-organic retinal prosthesis in a human eye has been investigated. To this aim, a different animal model, the pig, has been selected for its eye similarity to that of human beings, and proper device architecture has been implemented. Many possible candidates for the substrate material have been evaluated, including bacterial cellulose (BC), poly(ethyleneterephthalate) (PET), poly(lactic-co-glycolic acid) (PLGA), polycaprolactone (PCL), poly(methylmethacrylate) (PMMA). In each case, many different constraints have been considered, including solvent resistance, wettability, processability, thermal stability, mechanical properties. A combinatorial approach permitted to define the most

suitable protocols for the realization of a proper thin film substrate and the subsequent fabrication of the overall device. BC and PET has revealed to be the most suitable substrates for the realization of a scalable retinal prosthesis. Overall, this work provides a detailed characterization of organic based retinal prosthesis implanted in blind rats, and represents a useful starting point for subsequent engineering of artificial devices targeted to human beings.

FEMTOSECOND LASER MICROMACHINING FOR ADVANCED MANUFACTURING OF MICROFLUIDIC DEVICES

Sara Lo Turco - Supervisor: Luigino Criante

The experimental activity performed in this PhD Thesis context has been devoted to develop and integrate new functions for fluidic analysis purposes in lab-on-a-chip (LOC) devices, fabricated by femtosecond laser micromachining in glass. The idea below LOCs concept is the possibility to miniaturize and integrate several laboratory functions on a single substrate with dimensions ranging from hundreds of micrometers to few millimeters. The very first consequence of miniaturization is that small quantities of samples and reagents are used (10^{-9} to 10^{-18} litres) thus leading to a natural high resolution and sensitivity of detection together with short times for analysis. Other side benefits related to small size are the low cost, low energy consumption, reduced waste generation and more generally better controlled reactions which ensure safe work conditions. In short, LOCs are extremely portable devices which facilitate their diffusion in the healthcare market with the innovative idea to dispose of 'portable points of care', to be even used by non-experts and without any special equipment. In this regard we exploited the fs-laser assisted etching for fabricating the micro-devices, thanks to the intrinsic 3D potential of this technique

enabling a mask-less 'direct writing' of any sort of geometry inside the substrate, as in the ship-in-a-bottle idea. In particular, the micro-structures should be first irradiated by the femtosecond laser, with 3D motion-control, and then selectively removed by chemical etching leaving empty zones inside the substrate, thus producing the microfluidic platform. Furthermore the same tool (fs-laser) can be used to fabricate waveguides in fused-silica glass with a slight refractive index increase with respect to the surrounding volume. As a direct consequence, fluidic recirculation and optics detection are easily integrated in the same device, allowing a fast-prototyping of total-analysis-systems (micro-TAS). Easy network reconfigurability is visualized in fig. 1a. Considering the etching step, we explored the combination of the hydrofluoric acid (HF) for large volume removal and potassium hydroxide (KOH) for extreme precision fabrication (order of 1mm). When using one single etchant, the former tends to produce highly conical microchannels due to isotropic etching in the volume, whereas the latter is limited in etching strength requiring several hours for removing few hundreds of micrometers of irradiated fused-silica. Interestingly, the combined

use of both the etchants in subsequent steps enables the realization of complex platforms with innovative design and uniform internal structures. Thanks to this strategy, we successfully fabricated a micro-filter for particle separation and a fluidic-switch for fluid selection (reported in fig. 1b,c). The filter, composed of a grid of 2.05mm-size 15 x 15 pores and directly encapsulated inside a square channel, permits to separate different particle species in suspension. In particular, the internal dimensions are suitably engineered considering typical size of biological samples, where blood-cells and related material range between 1.5 mm-10mm in size. Regarding the second device, we demonstrated an extremely compact fluidic switch (1mm x 2mm) that can be connected to other systems by means of inlet/outlet insertions for full integration. The switch is composed of a T-shape channel with a movable glass-block inside, enabling to alternatively block port-1 or port-2 and select the output direction. Besides the described micro-mechanical components, we carried out a state-of-the-art study for integrating a laser microcavity directly inside the analysis device. Indeed the potentials of LOC systems can be significantly enhanced if disposing of source excitation

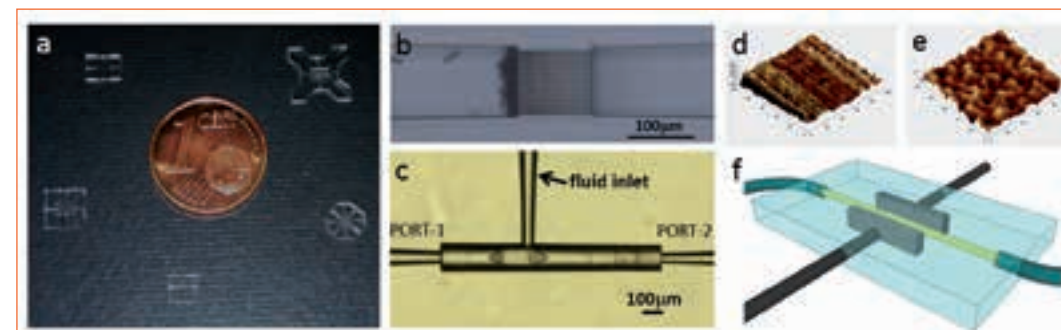

1:
 a) different microfluidic chips fabricated by fs-laser assisted etching;
 b) micro-filter blocking 7mm-beads immersed in water;
 c) T-shape microchannel with movable glass block acting as fluidic switch;
 d,e) AFM-based 2D-mapping revealing the surface roughness of d) top-wall and e) bottom-wall;
 f) Schematic design of the laser integrated microcavity.

and detection inside the microchip, allowing to reduce either the coupling and transmission losses as well as increase the device selectivity. Furthermore by exploiting the intrinsic high sensitivity of a laser cavity, the optical properties of fluid-samples can be easily monitored thanks to an *in-situ* highly sensible sensor. The first choice for laser integration in microfluidic systems is selecting high-gain dye-molecules diluted in liquid solvents as active medium, with emission covering the whole VIS region. As a direct consequence, due to high chemical degradability of any dye compound, fluidic recirculation results necessary in order to refresh new molecules in the cavity and enhance the laser life-time. Furthermore, an easy lasing-tuning is achieved by integrating wavelength-selective 'mirrors', constituted of Bragg gratings recorded by means of 2-beams holography within photo-polymerizable resins. In particular we selected this technique as it allows for a single-step volume grating realization, with high resolution

of 7500lines/mm and refractive index modulation up to $5 \cdot 10^{-2}$, thus permitting first-order operation in the VIS-region. Therefore, by merging the fs-laser micromachining for micro-device fabrication with the soft-matter holography for gratings imprinting, we aim at realizing an all-in-one platform for fluids analysis, with basic design displayed in fig. 1f showing the central microchannel filled with dye-solution, two side gratings acting as cavity mirrors, and the external connections. As first step, we optimized either the micro-device from the fluidic point of view and the photo-polymerizable mixtures chemistry in order to obtain high efficiency diffraction gratings with the selected configuration. Secondly, since the beams coherence during the holographic process results strongly affected by the intrinsic surface roughness left by fs-laser fabrication, we performed a detailed study in order to control and improve the surface quality. In particular, by means of AFM-based 2D mapping and corresponding spectral

domain inspection, we found out that the non-uniform energy distribution within the fs-laser focal-spot leads to a different surface structuring in the top-wall (fig. 1d) and bottom-wall (fig. 1e). In detail, the former case feels the periodicity of the laser-tracing whereas the latter one reveals a more random profile. This difference implies a different scattering of any light beam passing through the sample and, considering each particular application of the lab-on-a-chip, the surface profile can be controlled by suitably tailoring the fs-irradiation parameters: such as beam-shape, polarization, pulse energy and laser-traces spacing.

MECHANISMS OF CELLULAR PHOTOSTIMULATION IN HYBRID INTERFACES BASED ON ORGANIC SEMICONDUCTORS

Nicola Martino - Supervisor: Maria Rosa Antognazza

Hybrid interfaces between organic semiconductors and living tissues represent a new tool for *in vitro* and *in vivo* applications, bearing a huge potential, from basic researches to clinical applications. In particular, light sensitive conjugated polymers can be exploited as a new approach for optical modulation of cellular activity. It has been previously demonstrated that thin films of organic semiconductors used for photovoltaic applications are able to stimulate the bioelectrical activity of neurons grown on their surface upon illumination with pulses of visible light, both in the case of hippocampal neuronal cultures and of explanted blind retinas. This thesis is focused on the study of the functioning mechanisms of these hybrid interfaces, composed of a photoactive layer in contact with an electrolytic solution; the main absorbing material used is the prototypical conjugated polymer poly(3-hexylthiophene) (P3HT), in some cases blended with the electron acceptor phenyl-C₆₁-butyric acid methyl ester (PCBM). The study is carried out both from a photophysical and electrical point of view to understand the processes occurring at the hybrid interface upon illumination, and regarding the ability of the device to stimulate biological

cells. In particular, we are interested in understanding how photoexcitation of the active material in the device is able to modulate the potential of the plasma membrane, which is the main parameter controlling the firing of action potentials in excitable cells. First, the current strategies used for measuring and controlling bioelectrical activity are reviewed; after describing the evolution of electrical measurements and stimulation of cellular activity, particular attention is paid to optical techniques and the photoactive hybrid polymer interfaces are introduced. The experimental characterization of these hybrid polymer/electrolyte interfaces is presented, with a thorough investigation of their spectroscopic, electrical and thermal properties, in order to delineate the main phenomena that occur at the device surface upon illumination with short pulses of light (on the order of tens/hundreds of milliseconds). On these short timescales, the hybrid interface does not support an efficient electrochemical transfer of the charges photogenerated in the active material to the electrolytic solution. In contrast with standard organic photovoltaic cells, where charges are extracted by metal contacts, the hybrid device is not able to sustain

a continuous current upon illumination. Instead, a capacitive charging of the polymer/electrolyte interface is observed, similar to what happens in all-electrical silicon-based devices used for capacitive stimulation of neurons. Interestingly, the capacitive currents obtained in the polymeric devices upon photostimulation are comparable in intensity to those typical of electrically-driven inorganic devices; however, their temporal dynamics are quite short (on the order of 1 ms), due to the finite amount of charge that can be accumulated at the polymer/electrolyte interface. Once this capacitance has been charged, all the charges photoexcited in the active material during illumination recombine non-radiatively to the ground state. Thus, apart from a small fraction that is used to charge the interface, all the energy of photons absorbed by the material is dissipated into thermal vibrations leading to a local heating of the electrolyte at the device surface. Depending on the light intensity used, an increase in temperature on the order of few degrees can be observed after illumination with pulses of tens of milliseconds. The effects of photostimulation of the active material on cells were studied by growing HEK-293 cells on the hybrid interfaces. Being non-excitabile

cells, HEK-293 allowed to isolate the effects of photoexcitation on the basic properties of the membrane, investigated via electrophysiological methods and in particular with patch-clamp techniques. Apart from the capacitive charging of the interface, which is reflected in a spiking signal in the recorded potential of the cell, the illumination resulted in a biphasic effect, with an initial transient depolarization of the membrane followed by a prolonged hyperpolarization. Both these effects were attributed to the local heating of the system mediated by light absorption in the active polymer. In particular, the initial transient depolarization was related to an increase in the membrane capacitance with the temperature, consistently with recent reports on the mechanism of functioning of infrared neural stimulation (INS), in which water absorption of IR light is used to induce a local heating. This depolarization signal significantly depends on the electrical properties of the membrane, in particular its time constant (the product of membrane resistance and capacitance), with faster membranes (*i.e.* with a higher specific conductance) responding with lower depolarization signals upon illumination. The subsequent hyperpolarization

was instead attributed to a shift in the membrane equilibrium potential towards more negative values, determined by the electrochemical equilibrium of the ionic species on the two sides of the cell plasma membrane as described by the Goldman-Hodgkin-Katz equation, which strongly depends on temperature. To complete the description of the photostimulation process, a mathematical modelling of the dynamics of the membrane potential is proposed, which consistently reproduces the experimental data collected on the HEK-293 cells. The work is concluded by wrapping up the results in the context of existing techniques for cell stimulation and by pointing out to future

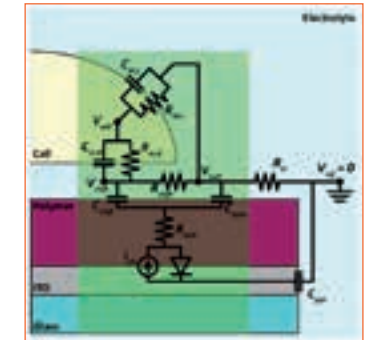

1. Electrical schematization of the coupling between the hybrid polymer/electrolyte interface and a biological cell described with a two-compartment model that considers the basal and the lateral portion of the plasma membrane. The green box represents the area of the device illuminated during stimulation.

developments, towards the creation of a multi-functional platform for light-controlled cell manipulation, with possible applications in different fields of neuroscience and medicine.

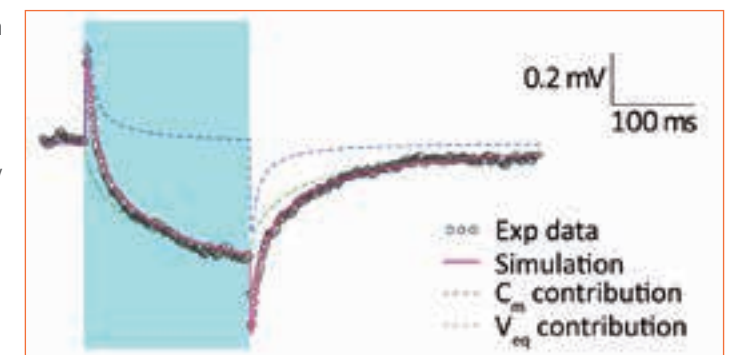

2. Variation in membrane potential measured on an HEK-293 cell upon illumination with a 200 ms pulse of light ($I = 57 \text{ mW/mm}^2$). The figure shows the comparison between the experimental results (grey open circles) and the numerical modeling of the system (pink solid line). The single contribution to the total signals from the variations in membrane capacitance (blue dashed lines) and equilibrium potential (green dashed lines) are also reported.

STRAIN ENGINEERING IN SI, GE AND SIGE ALLOYS

Valeria Mondiali - Supervisor: **Monica Bollani**

The need for an increase in the performance of microelectronic devices has pushed the traditional silicon-based architectures to their limits. One possible way to overcome these limits is identified in the use of strain engineering. This method allows an increase in performance of the devices through the ability to control the band structure of the semiconductor. Compressively strained silicon is used in high-speed electronic devices, and tensile germanium in optoelectronic devices. The use of thick films is hindered by the nucleation of dislocations, which decrease the performance of the devices, however using the dislocation engineering method it is possible to govern the nucleation and the propagation of dislocations at the nanoscale level.

Regarding the problem of strain control, a suitable nanopatterning of the SiGe layer induces, through the generation of edge forces, a compressive or a tensile strain, respectively for a Si or a Ge substrate. SiGe films were deposited by low-energy plasma-enhanced chemical vapor deposition (LEPECVD). SiGe nanostressors were realized by electron beam lithography (EBL) and reactive ion etching (RIE). Scanning electron microscopy (SEM) and atomic force microscopy (AFM)

were used to characterize the obtained structures. First of all, the SiGe-on-Si system was studied. The realized structures were characterized by μ Raman spectroscopy in order to study the strain state of the silicon as a function of the patterning of the SiGe film, obtaining a compressive strain of the Si substrate of 1%. Using finite element method simulations (FEM), it was possible to demonstrate that the strain induced in the substrate depends on the ratio between the width and the spacing of the stripes (Fig.1(a)). So, wide stripes with narrow gaps between them were needed to maximize the induced strain. After these promising results, the SiGe-on-Ge case was considered. In this case the goal was a uniaxial tensile strain higher than 4% in order to induce the transition to a direct band gap in the germanium. A simplified numerical model, which was very sensitive to the temperature, the growth rate, and the Ge content of the alloy, was developed to describe the strain relaxation process of tensile SiGe on Ge. In this way the optimum conditions for the growth of a metastable film were found. Also in this case the strain depends on the spacing between the stripes, and for a spacing of 20 nm the strain is higher than 4%,

so a direct band gap should be induced in the germanium. This strain can be enhanced using a Ge membrane instead of a bulk material. SiGe/Ge membranes were obtained using a wet etching process which preserves the SiGe layer, leading to the realization of high quality surfaces. The used anisotropic etchants, TMAH and KOH, allow a high Si/SiGe selectivity which is necessary to avoid damaging the stressors. These samples were analyzed by μ Raman spectroscopy, confirming the preservation of the SiGe layer on top of the Ge membrane. At this point the SiGe stressors were fabricated from the SiGe layer (Fig 1(b)).

Regarding dislocation engineering, a new method of controlling and engineering the dislocations was developed. Suitable patterns, realized by EBL, provided a controlling effect on the propagation of dislocations in an epitaxial SiGe film grown on the patterned Si substrate. The pattern was a matrix of inverted pyramid aligned along the $\langle 110 \rangle$ directions: these inverted pyramids acted as favourable points for the nucleation of dislocations. In this way, it was possible to control the propagation of dislocations along the pit rows. The ability to confine dislocations and obtain areas without dislocations

is an important target for the development of more efficient technologies, in fact in this way the dislocations are confined away from the active parts of the devices. A systematic study of different parameters (Ge content, film thickness and growth temperature) was performed to find the optimum conditions. All the samples were characterized by AFM, verifying that the dislocations propagate along the pit rows (Fig. 2(a)). This control effect was not confined only within the pattern

but extended over 20 μm outside the pattern. In this case the dislocations were always aligned along the direction of the pit rows, giving rise to areas in which dislocations ran in only one direction. The samples were studied by μ Raman spectroscopy and nano X-ray diffraction. This is the first case where μ Raman spectroscopy was used for the direct visualization of the dislocations present in a film. Through the μ Raman maps, it was possible to obtain information concerning the

strain, in particular it was found that the presence of dislocations resulted in a lower compressive strain in the film (Fig. 2(b)) and a greater tensile strain in the substrate. On the contrary, in the areas between the pits there was a greater compressive strain in the SiGe layer, proving that they were free of defects. Finally, the samples were characterized using TEM analysis in order to investigate the nature of the defects.

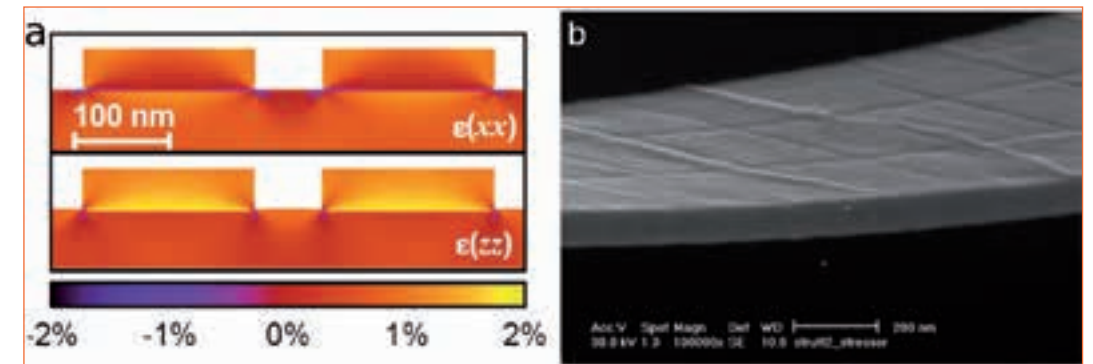

1. a) FEM simulation of ϵ_{xx} (upper panel) and ϵ_{zz} (lower panel) for SiGe/Si stripes. b) SEM image of SiGe nanostressors on top of a Ge membrane.

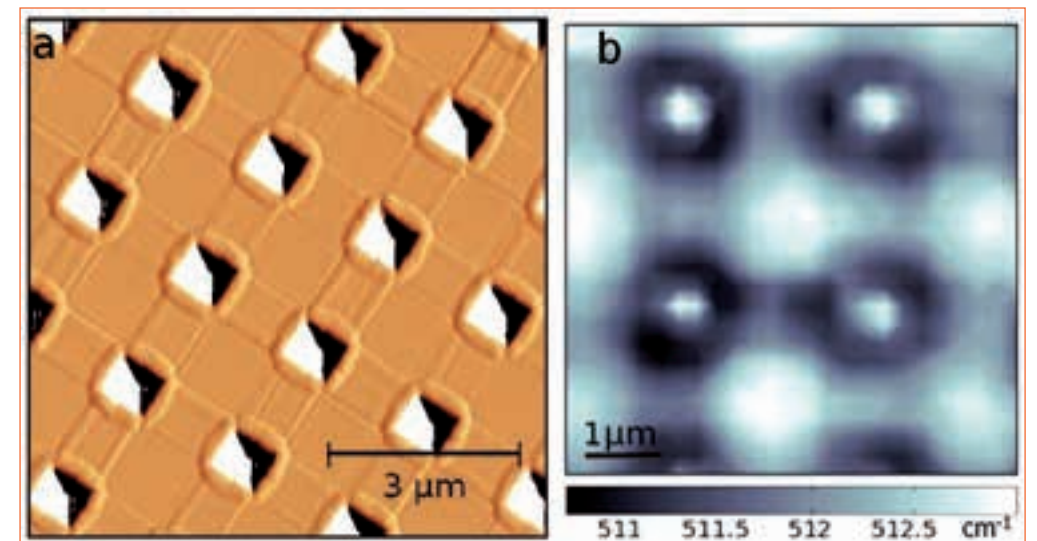

2. a) AFM image of the amplitude in tapping mode of SiGe on a pit-patterned substrates. b) μ Raman maps of the Si-Si peak of the SiGe film.

WATER-GATED POLYMER-BASED ORGANIC FIELD EFFECT TRANSISTORS FOR BIOSENSING APPLICATIONS

Rossella Porrazzo - Relatore: **Maria Rosa Antognazza**

This thesis investigates the fabrication and characterization of water-gated organic field-effect transistors (WGOFET), employing organic polymeric materials as the active semiconducting layer, for biosensing applications. Compared to a typical solid state top-gate transistor configuration, a water-based electrolyte substitutes the usual polymeric dielectric, allowing to work at very low voltages (<1V) typical of the biological systems, and opening for the possibility of development of a WGOFET-based biosensing platform.

In a first phase of the work we screen the most promising p-channel (holes conducting) semiconducting polymers to be used as active materials for WGOFETs: we finally focus on polymers of the polythiophene family, which exhibit remarkable performances in terms of charge carrier mobility and electrochemical stability as compared to previously demonstrated state-of-the art polymer-based WGOFETs, being able to work also in a biological-like environment (0.2 M molar concentration NaCl solutions). Notably, the critical comparison among different polythiophene-based polymers allows to unravel key physical mechanisms of the hybrid interface between conjugated polymers thin films and saline electrolytes.

By employing the best performing polymer among the selected ones, poly(2,5-bis(3-hexadecylthiophen-2-yl)thieno [3,2-b]thiophene) (pBTTT), an electrolyte gated pBTTT-based device is realized, sensitive towards pH and ionic strength of the electrolyte, being stable for more than 24 hours operation. Moreover, the device is modified with the enzyme penicillinase, and a proof-of-concept sensor specifically sensitive towards penicillin is demonstrated. Furthermore, two n-channel electron-conducting polymers are investigated for the first time as active materials in water-gated architectures, demonstrating outstanding performances. By coupling p- and n- type polymers, water-gated complementary inverters are realized, paving the way to the fabrication of complementary circuits working in a liquid environment.

TIME-RESOLVED INVESTIGATION OF ELECTRON DYNAMICS IN FEW-PARTICLE SYSTEMS USING A VERSATILE ATTOSECOND BEAMLINE

Maurizio Reduzzi - Supervisor: Giuseppe Sansone

The goal of the PhD project has been the development of a versatile high-repetition rate (10 kHz) XUV/IR attosecond beamline for time-resolved studies of electron dynamics in few-particle systems (atoms and small molecules).

The generation of XUV radiation was achieved via upconversion of Carrier-Envelope Phase (CEP) stabilized pulses centered around 800 nm with 5 fs duration, obtained via hollow-core fiber compression of the pulses produced by a commercial titanium-sapphire based laser system.

The production, via High-order Harmonic Generation (HHG) in noble gases, of subfemtosecond XUV pulses with duration down to 380 as was then demonstrated in *attosecond streaking* experiments; the combined exploitation of different generating media and metallic filters resulted in a broad frequency tunability in the 15-30 eV range.

From the technological point of view, the main challenge of the project was to interface the developed beamline with a REaction MIcroscope (REMI), a charged particle spectrometer capable of detecting multiple electrons and ions in coincidence, providing access to the momentum vector of all the detected fragments.

The detection of the generated

ionized fragments is the most natural way to follow in real time the dynamics of an atom (or a molecule) triggered by the interaction with a broadband XUV attosecond pulse. Because of the large bandwidth implied by the very short time duration of attosecond pulses, multiple reaction pathways are usually involved, complicating the interpretation of experimental results. It is then highly desirable to collect every possible piece of information from the process, *i.e.* to realize a kinematically complete experiment: this is the ultimate goal of a REMI.

The successful operation of the REMI inside the developed

attosecond beamline was demonstrated in streaking measurements for the characterization of isolated attosecond pulses (see Figure 1). It consists in a two-color XUV-IR ionization experiment performed on a noble gas. Provided that the dipole matrix element remains approximately constant within the bandwidth of the XUV pulse, the delay-dependent photoelectron kinetic energy distribution can be interpreted as a FROG spectrogram, allowing for the retrieval of the XUV pulse.

Furthermore, the REMI was used to study IR-assisted ionization of the helium atom, excited to the

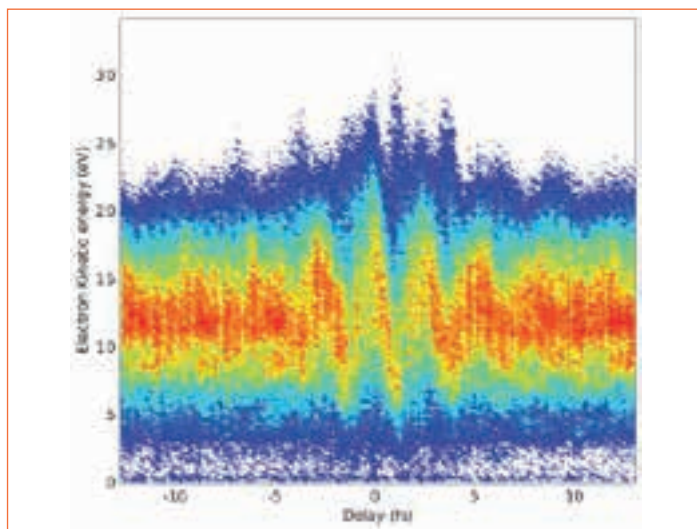

1. An experimental streaking spectrogram performed on argon. The XUV attosecond pulse was centered around 28 eV; 380 as is the pulse duration obtained from the retrieval algorithm.

$1snp$ manifold by the generated tunable attosecond pulses.

The main result of this experiment, corroborated with simulations based on the numerical solution of the Time-Dependent Schrödinger Equation (TDSE) in Single Active Electron approximation (SAE), was to highlight the presence of a transition in the dominant ionization pathway, depending on the intensity of the IR pulse: while at low intensity (lower than 3×10^{12} W/cm²) the dominating process is the two-photon process (1 XUV + 1 IR) stemming from the whole $1snp$ manifold (with $n > 2$), at higher intensities the four-photon process (1 XUV + 3 IR) from the $1s2p$ state becomes dominant. An important part of the project was also dedicated to the study of atoms and molecules with Attosecond Transient Absorption Spectroscopy (ATAS), where the observable is provided by the XUV radiation transmitted by a dilute gas sample, spectrally resolved thanks to a home-built XUV spectrometer.

This technique can be considered complementary to the REMI, since it provides access to the dynamics in the bound excited states of a system, which are invisible to a charged particle spectrometer since no ionization is taking place.

ATAS was applied for the first time to a molecular system (N₂) for the study of multi-electron dynamics. The population of a coherent superposition of electronic states lying below as well as above the ionization potential was demonstrated (see Figure 2); the coherence was proved by the observation of quantum beatings with a periodicity of 1.33 fs (one

half-cycle of the IR field), due to a two-IR-photon coupling between the two XUV-populated manifolds (one below and one above the ionization potential, respectively). The experimental results were supported with numerical calculations based on Time-Dependent Perturbation theory (TDP).

Finally, the technique was applied to singly-excited helium, which has been the subject of many similar investigations in the last few years. In particular, the novel contribution was the demonstration of a control over Light Induced States (LISs), which are absorption features appearing only in the simultaneous presence of an XUV exciting pulse together with a dressing IR pulse.

They can be thought as the (virtual) intermediate state connecting the ground state to a two-photon (1 XUV ±

1 IR) allowed bound excited state of the system. While the experimental observation of LISs was already established, the achievable control over their appearance exploiting the relative polarization between the XUV and the IR pulse was the subject of our investigations. The result was qualitatively explained thanks to symmetry arguments in a Floquet-like model; quantitative agreement was provided by simulations based on the solution of the TDSE in SAE.

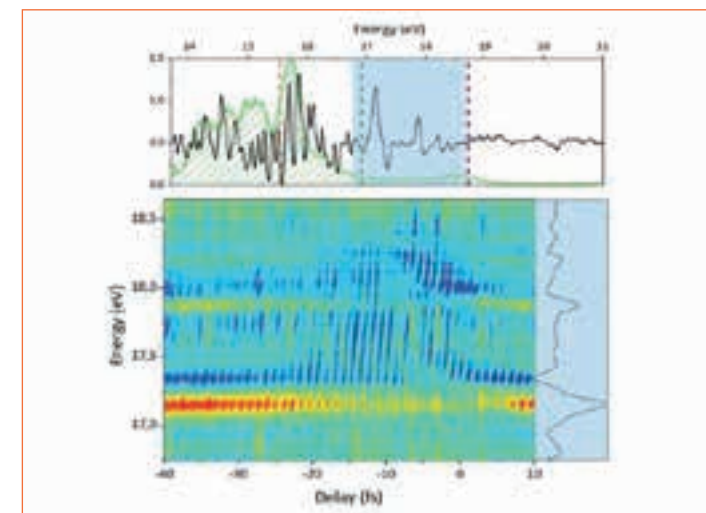

2. Experimental observation of a coherent electron wavepacket in N₂. The transient absorption trace shows half-IR-cycle oscillations in the region 17.0 - 18.5 eV (lower panel) as a result of the interference between the single XUV photon (tail of the XUV spectrum - green shaded area in the upper panel) and the three-photon (absorption of one XUV photon - center of the green shaded area - followed by absorption of two IR photons) pathways leading to the population of the same state states (blue shaded area).

NANO-OXIDES ON A REACTIVE SUBSTRATE

A scanning tunneling microscopy study of transition metal oxides on Fe(001)

Michele Riva - Supervisor: Lamberto Duò

Stimulated by technological applications of oxides in catalysis, electrochemistry, gas sensing, corrosion protection, electronics and high-density storage, considerable scientific effort has been spent in the last decades to the investigation with atomic-scale resolution of oxide surfaces and metal/oxide interfaces. In particular, a growing attention has been paid to the investigation of structural, electronic and magnetic properties of the surfaces of bulk crystals and ultrathin oxide films supported on noble-metal substrates. The latter have been the subject of extensive research (i) as model inverse catalysts, and (ii) due to their rather facile preparation by reactive metal deposition (RD) in oxygen atmosphere, thanks to the inert noble metal support. Comparatively much less efforts have been spent on the investigation at the nanoscale of oxides coupled with substrates characterized by an elevated reactivity toward oxygen, such as Fe [Fig. 1(a), top]. The question of how oxides form on top of a reactive metal is, nevertheless, of apparent relevance, e.g., concerning the use of oxides as protective coatings. Moreover, investigation of the effects of the reactive support on the local electronic properties, chemical composition and defect distribution of the growing oxide

is crucial in view of possible catalytic applications. Finally, the large majority of materials possessing long-range magnetic ordering belongs to the class of reactive metals. In this respect, new exciting properties can arise from the interfacial interaction of oxides possessing long-range spin ordering and their magnetic support. In particular, technologically relevant phenomena, currently exploited in high-density storage media, spintronics and magnetic field sensing, still await suitable model systems to allow a profound understanding via atomic-scale probing. Indeed, the high reactivity of magnetic supports as Fe poses serious limitations to the preparation methods for well-defined oxides, i.e., ideally characterized by atomically flat surfaces, and chemically and structurally abrupt interfaces with the substrate. O₂ exposure, in fact, readily induces the formation of substrate oxide phases [Fig. 1(a), bottom], whose structure and chemical composition are hardly controlled. As a result, oxides grown by RD on reactive substrates like Fe exhibit rough surfaces and diffuse interfaces, hampering both atomic-scale imaging via scanning tunneling microscopy (STM) and idealized modeling. The research activity of my

PhD aimed at achieving a deeper understanding of the subtle mechanisms occurring when interfaces between nanostructured transition metal (TM) oxides and a magnetic Fe(001) substrate are formed. In particular, three main strategies have been adopted to achieve the preparation of high-quality Cr, Co and Ni nano-oxides. (i) TM growth on a well-ordered, pre-oxidized Fe(001) surface, i.e., Fe(001)-p(1×1)O [Fig. 1(b)]; (ii) post-oxidation of, and (iii) homoepitaxial RD onto ultrathin TM buffer layers, grown on either Fe(001) or Fe(001)-p(1×1)O. Fig. 2 reports a restricted selection of the STM results. Growth of sub-ML (1 ML = 1.2×10^{15} at./cm²) amounts of Cr on Fe(001)-p(1×1)O leads to the stabilization of two monolayer-thick oxides with Cr₃O₄ [Fig. 2(a)] and Cr₄O₅ [Fig. 2(b)] stoichiometry, unobserved among bulk Cr oxides. Conversely, Ni/Fe(001)-p(1×1)O growth leads to the formation of an alloy oxide surface, with Ni₄FeO₅ stoichiometry [Fig. 2(c)]. A similar tendency of Fe atoms to get oxidized is strikingly observed when oxidation of Ni/Fe(001) films is considered [Fig. 2(d)]. In this case Fe atoms migrate through the Ni buffer and form a buckled FeO nano-oxide with a polar (111) orientation.

The results achieved during my PhD could pave the way toward a deeper understanding of heterostructures formed by magnetic oxides supported on ferromagnetic substrates, especially considering the great progresses achieved in direct observation of spin structures down to the atomic scale via spin-polarized STM. Moreover, the peculiar structures formed by these oxides in direct contact with a reactive substrate could prove promising candidates as novel model catalysts.

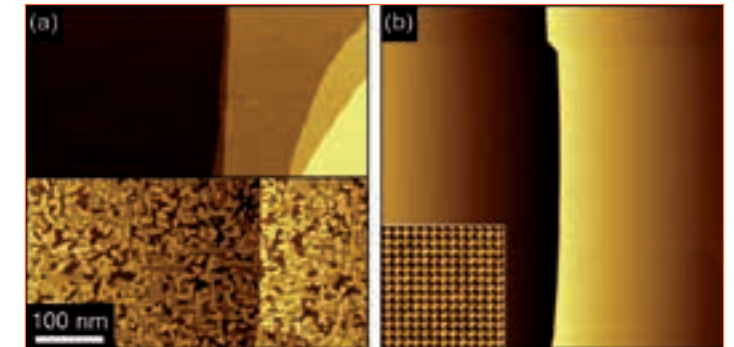

1. Large-scale STM images of (a) the Fe(001) substrate before (top) and after (bottom) exposure to 50 L (1 L = 1.33×10^6 mbar s) O₂ at room temperature, and (b) the Fe(001)-p(1×1)O surface. An atomically-resolved STM image (3.8×3.8 nm²) of Fe(001)-p(1×1)O is reported in the inset of panel (b).

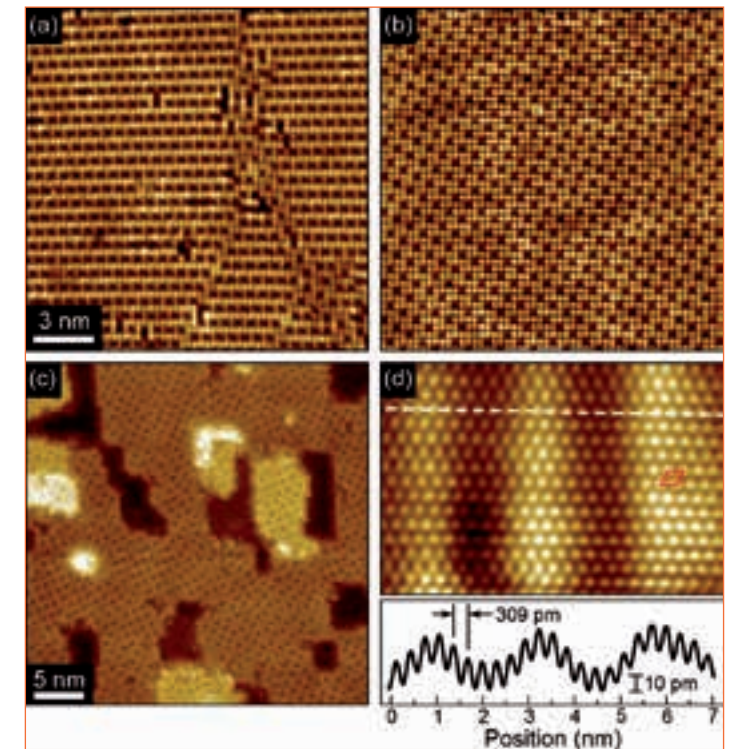

2. (a,b) Atomically-resolved STM images of single layer-thick Cr oxides prepared by growing (a) 0.75 ML, and (b) 0.80 ML Cr on Fe(001)-p(1×1)O at 670 K. The presence of ordered Cr vacancies (dark spots in STM) results in Cr₃O₄ and Cr₄O₅ formal stoichiometry for the nano-oxides in (a) and (b), respectively. (c) STM morphology of a 5 ML-thick Ni/Fe(001)-p(1×1)O film grown at 570 K. At variance with respect to (a,b), the dark spots in (c) have been identified as single Fe atoms. The formal stoichiometry of this alloy nano-oxide is therefore Ni₄FeO₅. (d) Atomically resolved STM image (top, 7.0×4.8 nm²) and line profile (bottom) of the polar FeO(111) nano-oxide (surface unit cell sketched in red) developing when a 5 ML Ni/Fe(001) film is exposed to 150 L O₂ and post-annealed to 570 K.

FROM DYE SENSITIZED TO PEROVSKITE-BASED SOLAR CELLS: A PERSPECTIVE ON THE FUNDAMENTAL WORKING MECHANISMS EVOLUTION

Vittoria Roiati - Supervisor: Prof Guglielmo Lanzani

Sunlight is the most abundant renewable energy source on earth, it would then potentially enable sustainable economic growth for humanity with a minimum detrimental impact on the environment, if properly converted and stored. Among the photovoltaic technologies developed to convert solar power, silicon-based ones are the most consolidated in industry. There are, however, many alternatives, promising cheaper, environmental-friendly solutions, with characteristics suitable for various technological applications. Among these, Dye-Sensitized Solar Cells (DSSC) are mostly coming of age, providing potential penetration into high-added value energy markets, such as the BIPV (Building-Integrated Photovoltaics), unattainable by classic inorganic semiconductor based photovoltaics. DSSC solar cells are based on the light harvesting operated by a sensitizer "antenna" through electron injection into the conduction band of a nanostructured semiconducting oxide, followed by dye regeneration by a redox shuttle liquid electrolyte or solid hole transporting material. Huge efforts have focused in the last 20 years on the development of new efficient materials and innovative architectures for DSSC, in order to improve device performances, progressing

in the roadmap towards the widespread applications of this technology. Hybrid organic-inorganic perovskites have emerged at the forefront of the most exciting and innovative materials for this application in recent years. Initially proposed as an evolutionary step of mesostructured solid state sensitized solar cells, they soon demonstrated ground-breaking performances, soon reaching outstanding solar to electricity conversion efficiency close to 20%, and holding the promise of accessible scalability with low-cost solution processability. Hybrid halide perovskite possess key characteristics for PV manufacturing: intense and broad light absorption, remarkable ambipolar charge mobility and very low non-radiative carrier recombination rates, leading to impressive charge diffusion length. These fascinating properties allowed the inclusion of perovskite materials in a variety of device architectures in the last couple of years, exploring different manufacture procedures including spin coating and evaporation of thin films. The characterization perovskite-based solar cells (PSC) offers several challenges to the scientific community, which has been involved in the last decade in the study of DSSC. In fact these devices present interesting

peculiarities when analysed with conventional tools employed for DSSC characterization. In this thesis, Time Correlated Single Photon Counting (TCSPC), Photoinduced absorption (cw-PIA), Transient Photovoltage (TPV) and Electroabsorption (EA) are employed to shed light on charge dynamics and interface physics of both class of devices. Experimental evidences show that the models developed for data interpretation in DSSC analysis have to be reconsidered when dealing with perovskite solar cells (PSC). The comparative analysis between the "old" and the "new" generation of mesostructured solar cells is completed with a punctual review of the hot debate of the scientific community around each of the investigated aspects. Two main topics are presented and experimentally supported by the author:

1. Charge injection to the TiO_2 matrix is limited in mesostructured PSCs, contrary to the case of conventional dye-sensitized solar cells. This implies that, after charge separation in the perovskite itself, electrons are mainly transported towards the selective contact through the same active material. This behaviour is hypothesized following different experimental

evidences obtained with independent methods. First, TCSPC analysis revealed that for hybrid halide perovskites PL quenching is not related to charge extraction but mainly to the morphological and crystalline structure of the perovskite film. Contrary to the case of DSSC, then, no charge injection rate can be retrieved for luminescence decay analysis as some groups reported in early works. Second, cw-PIA showed very weak feature attributable to the absorption of electrons in the TiO_2 matrix in efficient state-of-the-art devices. Efficient injection and fast charge recombination would justify this result, but it would be in contrast with the observed good performances of the solar cells. Third, TPV revealed a double path for charge recombination, with a slower component attributable to the charges injected in the TiO_2 substrate, recombining with the typical dynamics observed for solid state DSSC, and a faster component attributable to the electrons percolating through the perovskite material. The fast recombination component does not negatively affect the performances of the devices since it is coupled with efficient and fast transport, as demonstrated by means of transient photocurrent in the same samples. The cartoon in figure 1 shows schematics of the hypothesized double path for charge carriers in mesostructured perovskite solar cells.

2. EA spectroscopy has been employed to demonstrate the influence of the oxide

mesoporous scaffold on the morphological and structural properties of perovskites. As observed by others for the case of DSSCs, first derivative features often superimposed to cw-PIA spectra are due to local electric fields originated by charge displacement after excitation and acting on ground-state dye molecules (described as oriented dipoles) according to the linear Stark effect theory for absorption shift. Mesostructured PSCs, in cw-PIA and EA experiments, showed derivative features similar to the DSSC case, revealing the presence of oriented dipoles at the interface between perovskite and mesoporous oxide. The orientation provided by the interaction with TiO_2 could influence perovskite growth and transport properties; moreover, the presence of electric dipoles in perovskites, which appear to have a strong influence in PSC working mechanism, has been experimentally tested. Figure 2 provides a schematic view of the direction of the dipole moment variation $\Delta\mu$ and the corresponding linear Stark signal for oriented dipoles. Left: DFT calculated ground and excited state dipole moments for the system.



1. Cartoon illustrating the double path for electrons percolation in mesostructured PSC, with slow and fast dynamics associated to TiO_2 and perovskite transport respectively, hypothesized according to TCSPC, cw-PIA and TPV analysis.

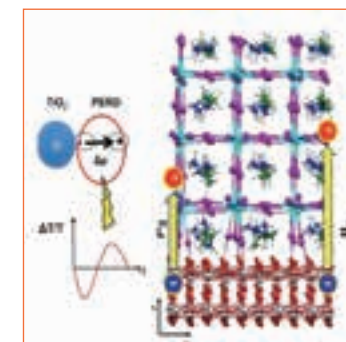

2. Right: schematics of dipole moment variation for the TiO_2 /perovskite (PERO) interface and shape of the corresponding linear Stark signal for oriented dipoles. Left: DFT calculated ground and excited state dipole moments for the system.

COMB-ASSISTED CAVITY RING-DOWN SPECTROSCOPY

Tommaso Sala - Supervisor: Marco Marangoni

The fields of frequency metrology and trace gas sensing historically developed along two separated paths. In the last decade, the former benefited from the advent of optical frequency combs (OFCs), enabling the absolute calibration of optical frequencies. The latter has witnessed over the past twenty years continuous methodological and technical developments leading to more and more sensitive spectrometers, especially when combined with high-finesse optical cavities, while little attention has been paid to the frequency accuracy of the measurement. For this reason the connection between these two fields is particularly attractive.

The huge success of OFCs lies in their discrete, stable and reproducible structure, readily referable to primary microwave standards, allowing the link between the optical and the radio frequency (RF) domain and providing an absolute frequency axis to any spectroscopic recording.

Bringing the benefits of OFCs into the field of molecular spectroscopy and trace gas sensing is the main goal of this thesis. To the purpose of the enhancement of the measurement sensitivity, several spectroscopic techniques have been developed. Among all the

various techniques, cavity ring-down absorption spectroscopy (CRDS), proved to be very powerful and effective. It is based on the measurement of the photon decay rate inside a high-finesse optical cavity, with high sensitivity and immunity to probing laser intensity noise. Our aim is the development of a comb-assisted, continuous wave (CW) CRDS setup that can provide the high accuracy on the frequency axis offered by an OFC and at the same time high sensitivity on the vertical scale. An absolute frequency axis adds several features to a high-sensitive spectroscopic measurement. It enables ultrahigh precision and accuracy, with frequency uncertainties on the line positions as low as 10^{-16} , and also ensures an increased signal-to-noise ratio and sensitivity thanks to massive averaging of precisely calibrated spectra. These characteristics help to solve many open questions, such as the analysis of the impact of line-shape models on the spectroscopic parameters, providing deep physical insights on the collision processes of molecules. This also permits the absolute determination of molecular line centre frequencies and linestrengths with unprecedented precision and accuracy, allowing tests of quantum-mechanical calculations of the energy levels

structure and dipole moment of molecules.

In this thesis we present a new approach to comb-assisted CRDS, where high sensitivity and frequency accuracy are obtained by using a high-finesse optical cavity ($F \approx 100000$) and by locking a CW probing laser to one mode of an Er: fiber OFC in the near-IR, respectively. A wide-bandwidth phase lock between the OFC and an extended cavity diode probing laser (ECDL) is achieved by using their beat note as the driving signal of an acousto optic modulator (AOM) in a feed-forward configuration, cancelling the frequency fluctuations of the ECDL with respect to the stable OFC. The coherence properties of the comb are efficiently transferred to the CW probing laser, whose frequency noise is reduced with a maximum control bandwidth of 0.8 MHz. This ensures a high spectral purity of the probing laser and very high reproducibility and accuracy to the frequency axis upon scanning the comb repetition rate. The use of an AOM in this setup is very effective because, besides providing for the probing laser line-narrowing and referencing, it is also used to interrupt the laser beam and to start the ring-down event once a reasonable intensity threshold is measured (Fig. 1).

The spectral scan is performed by tuning the comb repetition rate while maintaining the tight lock between the probing laser and the OFC. This approach minimizes the frequency offsets that could emerge between ECDL and comb during the spectral scans. The setup is fully automated by using a real-time system equipped with an FPGA, providing to a piezoelectric actuator the sawtooth signal needed to dither the cavity length and performing a cavity length tracking in order to maintain the dithering of the cavity resonance centred around the probe laser frequency during a spectral scan.

The test of the spectrometer performances was performed on the P14e line of CO_2 at $1.57 \mu\text{m}$ at low pressure (Fig. 2). The measurement of the decay rate $1/\tau$ is related to the gas absorption by the law $\alpha = (c\tau)^{-1} - (c\tau_0)^{-1}$, where $1/\tau_0$ is the decay rate of the empty optical cavity. The huge density of spectral points and the high signal to noise ratio of the recording make this system ideal for an accurate line-profile analysis. A limit of detection on the vertical axis as low as $1.6 \cdot 10^{-10} \text{ cm}^{-1}$ is found over a single spectral scan which consists of 1500 spectral points acquired over 75, as limited by temporal drifts of the empty cavity and by parasitic etalons, as highlighted by the analysis of the Gaussian fit residuals. Several statistical independent measurements were repeated to get an insight into precision and accuracy of the line centre frequency retrieved from the fitting, demonstrating an error of 38 kHz on the line centre determination in a Doppler

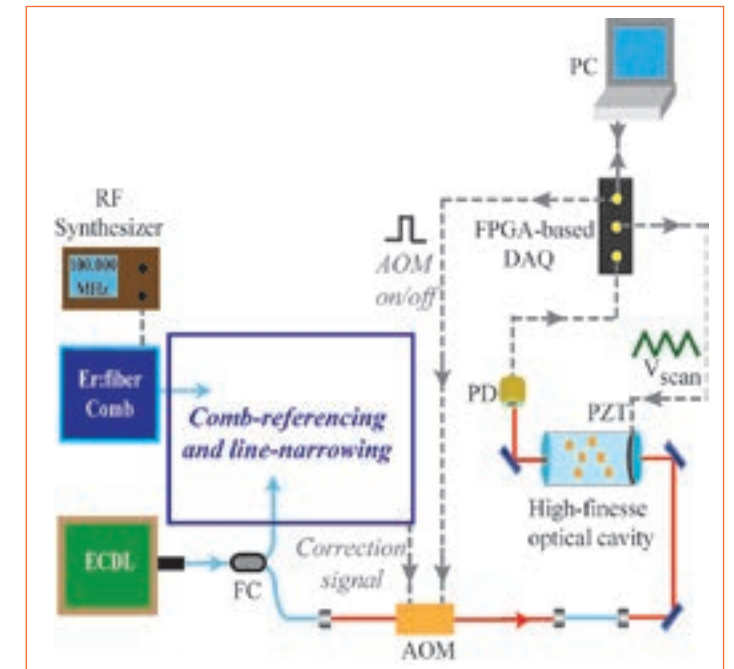

1. Experimental setup of the comb-assisted CRDS spectrometer. Blue lines indicate fibre paths. FC: fibre coupler. DAQ: acquisition board; PZT: piezoelectric actuator; PD: photodiode.

broadening regime in single spectral acquisition. When averaging over several scans the statistical uncertainty in the line centre frequency reaches 9 kHz, with the absence of systematic errors on the frequency reading. This setup, besides attesting the undisputed advantage given by a comb-based spectrometer, also shows that comb-based highly sensitive detection allows frequency accuracy to be straightforwardly pushed to the typical kHz-level of the sub-Doppler regime. In conclusion, we have introduced a new configuration that allows conjugating very high performance on both the horizontal and vertical scale. This ranks the system close to the state of the art of comb-assisted spectrometers, without

the need of GHz electro-optical modulators that do not exist outside the telecommunication spectral region.

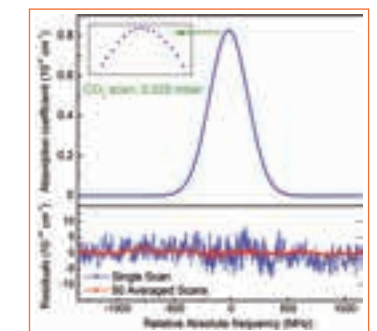

2. Top) Typical single-scan absorption spectrum at a pressure of $2.5 \cdot 10^{-2}$ mbar for the P14e line of CO_2 . Bottom) Residuals of a Gaussian fitting for a single-scan and for a 50-times averaged spectra.

ULTRAFAST PHOTOPHYSICS OF LOW DIMENSIONAL MATERIALS

Giancarlo Soavi - Supervisor: Prof. Giulio Cerullo

Nanotechnology, the characterization and exploitation of objects with dimensions in the order of 1-100 nm, represents nowadays a fruitful platform for advanced technologies and a challenge for future applications. Besides the empirical use of nanostructures in ancient times for ornamental purposes, such as the Lycurgus Cup (4th century AD, Rome) with its iridescent colours or the glittering stained glass windows of the medieval cathedral of Sainte-Chapelle (1242, Ile de la Cité, Paris), the modern interest for the field was triggered by the visionary talk of R. Feynmann, *There's Plenty of Room at the Bottom* (1959). On the other hand, the invention of the Scanning Tunneling Microscope in 1981 by G. Binnig and H. Rohrer, both awarded with the Nobel Prize in Physics in 1986, is often referred as the watershed in nanoscience, as it represents the first tool to directly observe matter with sub-nanometer resolution. Thus, we are nowadays experiencing the results of approximately half-century of intense nano-research, with a large number of discoveries and applications that are more and more affecting our everyday life. In this work we concentrate on the ultrafast optical properties of two classes of nanomaterials: Carbon Nanotubes (CNTs) and Gold Nanoparticles.

CNTs are the one-dimensional allotropic form of carbon and they were first discovered in 1991 by S. Iijima. With all its different allotropic forms, carbon played a key role in the technological advances of our society. Graphite, the most stable and common carbon allotrope, has a layered and planar structure formed by carbon atoms arranged in a honeycomb lattice. Its first large scale application dates back to the 16th century, when the discovery of an enormous deposit in Borrowdale (UK), used by the locals for marking sheep, led to the birth of the pencil industry. The advent of the low-dimensional carbon allotropes (fullerene, CNTs and graphene), instead, had to wait until the second half of the 20th century. Fullerene (the ideal 0D system formed by carbon atoms on a hollow sphere) was found experimentally only in 1985 by H. Kroto *et al.* and earned the Nobel Prize in Chemistry in 1996 to R. Smalley, H. Kroto and R. Curl. Graphene, a one atom thick carbon layer, is the youngest among the carbon allotropes. It was isolated and detected for the first time in 2004 by the group of A. Geim and K. Novoselov, both awarded with the Nobel Prize in Physics in 2010. Recently, Nature has published the list of the 100 most cited research of

all time. In the field of physics the discovery of CNTs and the discovery of graphene are at the first and third position respectively. Despite the huge number and diversity of possible applications of these low-dimensional allotropic forms of carbon, the easiest example to explain their importance is probably electronics. Being already at the physical limit for the Moore's Law, where the quantum mechanical effects can no longer be neglected, the further miniaturization of transistors calls for completely new methodologies. Circuits made of graphene and CNTs would benefit both from the smallest possible size, limited by the dimension of atoms, and the highest ever known carrier mobility, exceeding by approximately two orders of magnitude that of silicon. Gold nanostructures are metallic systems of nanometer size with unique optical properties that arise from the so called Localized Surface Plasmons, namely free electrons collective oscillations coupled to an external electromagnetic field. The technological importance of gold nanostructures hails from the large variety of possible applications, including non-linear frequency conversion, high resolution imaging, photovoltaics, biological sensing and imaging, cancer therapy,

biodiagnostics and integrated optical devices. In this respect, the possibility to control the electronic and optical properties of gold nanoparticles by changing their geometry and nanocrystallinity together with their strong sensitivity to the environment are of fundamental importance. The study of the ultrafast optical response of gold nanoparticles allows to selectively address the series of relaxation processes that fully characterize the temporal evolution and interactions of plasmons, electrons and phonons inside the material. When the photon energy of an excitation pulse falls inside the absorption spectrum of the gold nanoparticle plasmonic resonance, coherent oscillations of the electron sea can be launched. These oscillations lose the phase information (plasmon dephasing) within approximately 10 fs and transfer the whole absorbed energy to the electronic distribution. Then, in the first 100 fs the electrons relax from a non-thermal to a thermal electronic distribution via electron-electron interaction and subsequently transfer energy to the lattice via electron-phonon interaction. Finally, the cooling of the lattice takes place on a relatively slow time scale (in the order of the ns) by energy transfer to the environment, i.e. phonon-phonon interaction,

which brings back the system to the thermal equilibrium. In this thesis we exploit ultrafast pump-probe spectroscopy to define the time-scale and mechanisms of the energy relaxation processes, interactions with the environment and

carrier mobility in these two classes of low-dimensional materials. A deep understanding of all these factors is a fundamental prerequisite for further development of their technological applications.

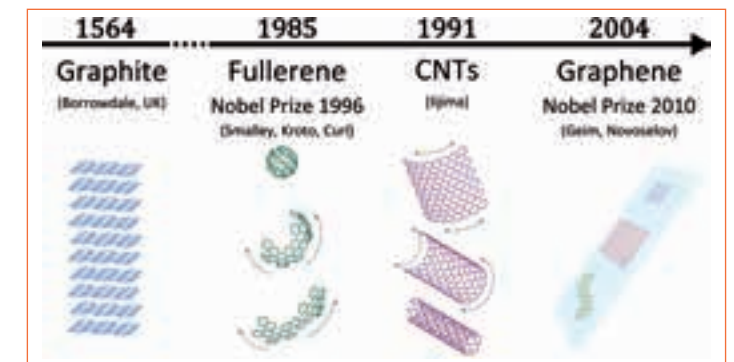

1. Timeline of the carbon allotropes, from graphite to graphene. The pencil industry was born in 1564 thanks to the discovery of a graphite deposit in Borrowdale. Graphene is considered the fundamental building block for this class of low-dimensional materials, obtained by wrapping-up (fullerene), rolling-up (CNTs) or stacking (graphite) a single-atom layer of carbon.

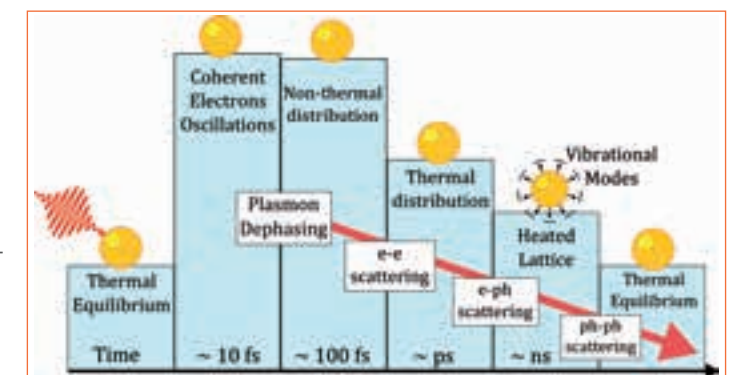

2. Schematic picture of the relaxation processes following ultrafast optical excitation in gold nanoparticles.

ATTOSECOND ELECTRON DYNAMICS IN COMPLEX MOLECULAR SYSTEMS

Andrea Trabattoni - Supervisor: Prof. Mauro Nisoli

In 1981 Zewail and coworkers published a pioneering work on quantum coherence effects in the vibrational states of anthracene, paving the way for the study of ultrafast dynamical processes in isolated molecules. In the same years the laser sources were experiencing a dramatic development thanks to the appearance of the first subpicosecond dye lasers (1974) and, few years later, the achievement of pulses with a duration down to 6 fs (1987). The great results on both sides converged in the development of ultrafast spectroscopy and femtochemistry, providing an "ultrahigh-speed photography" at the atomic and molecular level. Nowadays this research field is really well established and gives a direct access to dynamical processes of great importance in physics, chemistry and biology. From quantum mechanics we know that femtosecond temporal scale is intrinsically related to the nuclear motion, for this reason a typical experiment with femtosecond resolution is able to investigate in real time the evolution of a reaction, the breaking of a chemical bond, the fragmentation of a complex system after the perturbation of the initial quantum state, down to the vibrational oscillation in diatomic molecules (the ground state vibrational period of H_2 is

in the order of 10 fs). Electron dynamics occurs on a faster temporal scale ranging from a few fs down to a few hundreds as ($1 \text{ as} = 10^{-18} \text{ s}$), for this reason in order to track the electronic motion in matter shorter light pulses are required. In 1987 and 1988 two independent experiments were able to produce coherent extreme ultraviolet (XUV) radiation by exploiting the interaction between a strong IR laser field and the atoms of a rare gas. The result was a series of odd harmonics of the fundamental wavelength, corresponding to a train of subfemtosecond bursts. Only few years later this process was fully understood and called High Harmonic Generation (HHG). Since then, great effort was made to investigate more in detail the HHG process, until the first experimental demonstration of attosecond pulses generation, performed in 2001 by Paul and coworkers, who were able to generate a train of 250 as pulses. During the same year a single attosecond pulse with a time duration of 650 as was successfully isolated from a train of attosecond pulses. These results paved the way for the birth of attosecond physics. In the last two decades a strong effort was made to characterize attosecond sources and to apply this

technology to the investigation of ultrafast electronic dynamics in matter. The main problem the community has to face is the low intensity of attosecond sources, since the conversion efficiency of HHG process is quite low (in the order of 10^{-6}), resulting in XUV energies usually in the range between hundreds of picojoules up to few nanojoules. This level of energy, and correspondent intensity, is typically too low for initiating non linear processes in matter, thus for performing attosecond-pump attosecond-probe experiments. For this reason the common solution is to combine the XUV pulses with a VIS/NIR laser field, with an attosecond-pump femtosecond-probe configuration. This setup can still preserve a temporal resolution in the attosecond timescale and in the last years gave important results in investigating ultrafast electron dynamics in atoms, and recently even in simple molecules. Despite these positive results, attosecond physics still didn't show the capability of investigating complex systems, for example biomolecules, where ultrafast electron dynamics are expected to play a fundamental role in many biological processes such as catalysis, respiration, DNA damage by ionizing radiation and photosynthesis. This thesis describes attosecond-pump femtosecond-probe

experiments performed with attosecond temporal resolution, with the aim of studying electronic dynamics in complex molecular systems. First we investigated ultrafast relaxation process in multielectron diatomic molecules. We concentrated on the N_2 molecule, that is the most abundant species in the Earth's atmosphere, with the goal of understanding the interaction of molecular nitrogen with extreme ultraviolet (XUV) radiation, that is of crucial importance to completely disclose the atmospheric radiative-transfer processes.

By performing a Velocity Map Imaging (VMI) experiment, we were able to disclose the ultrafast dissociative mechanisms leading to the production of N atoms by XUV photoionization, and to observe a predissociation quantum interference between the electronic states of the molecular cation. We also managed to extract information about the slope and shape of nitrogen (in particular N_2^+ ions) potential curves, a sort of "real-time mapping" of molecular electronic states. Then we tried to push our investigation to more complex

systems with the aim of studying ultrafast electronic dynamics in molecules of biological interest. We performed a mass spectrometry experiment on Phenylalanine (one of the essential amino acids) and analyzed the temporal evolution of molecular fragmentation after XUV ionization. We were able to measure a charge oscillation in the yield of immonium dication fragment, providing for the first time an experimental demonstration of charge migration in a biological molecule.

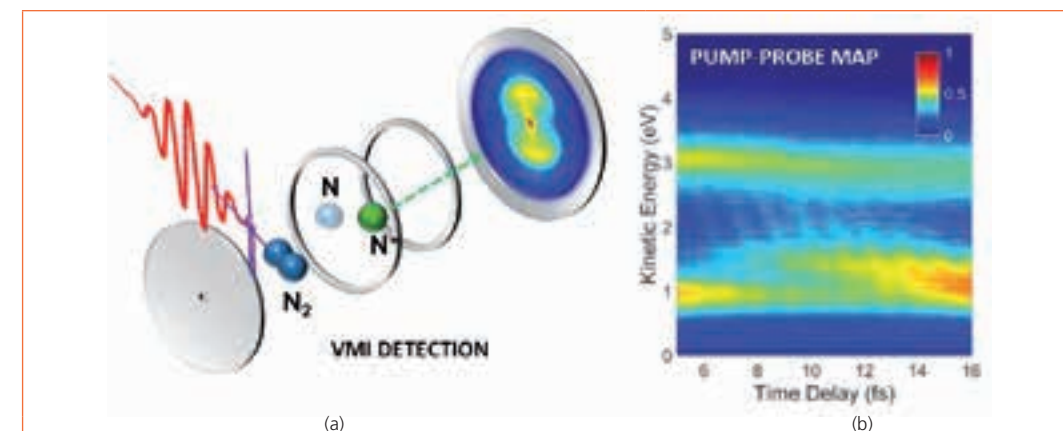

1 (a) Photoionization experiment on molecular nitrogen performed in a Velocity Map Imaging (VMI) spectrometer. (b) Pump-Probe map of the N^+ Kinetic energy, as a function of the delay between attosecond-pump and few-femtosecond-probe pulses.

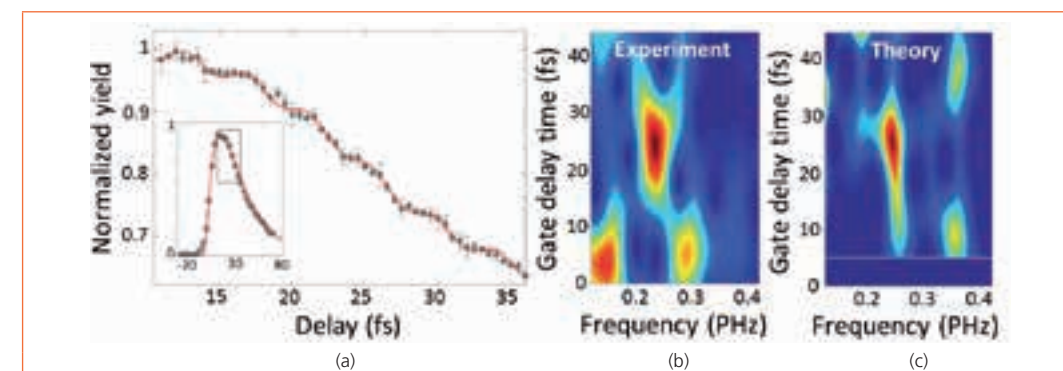

2 a) Oscillatory dynamics on the decaying slope of the delay-dependent yield of immonium dication (reported in the inset in a 100-fs delay range). b) Sliding-window Fourier-transform of the experimental data. c) Sliding-window Fourier-transform of the numerical result.

AUGER ELECTRON MICROSCOPY FOR THE CHARACTERIZATION OF 1D AND 2D NANOSTRUCTURES

Mohammad Javad Vahid Dastjerdi - Supervisor: Prof. Alberto Tagliaferri

Scanning Auger Microscopy (SAM) is an electron spectro-microscopy technique that joins the imaging resolution of Scanning Electron Microscopy (SEM) and the analytical power of Auger Electron Spectroscopy (AES). In addition to the imaging capabilities provided by SEM, potentially down to the nanometer scale, in a SAM apparatus the focused electron beam from the SEM column is exploited to generate Auger electrons, which are filtered by the AES analyzer. AES is able to provide semi-quantitative atomic concentration and chemical analysis of the few atomic layers at surface of a sample. Thus, SAM is potentially able to give a relevant insight into the surface electronic, chemical and structural properties of nanostructured systems, with nanoscale lateral and sub-nanoscale depth resolution. These capabilities make SAM a very valuable tool for the investigation of today's nanostructured solid state systems, with a large variety of applications ranging from sensing to nano electro-mechanical and energy harvesting devices and to catalysis. This work exploits the SAM capabilities, complemented with the use of several other microscopic and spectroscopic technique, like Atomic Force

Microscopy (AFM) and micro-Raman spectroscopy, to investigate two prototypical nanostructured systems: (1) 1D Tungsten oxide nanorods and (2) 2D graphene and graphene oxide (GO) single and multilayer films. In the first section, the investigation focus on the chemical-physical conditions at the surface of amorphous-like Tungsten films, which have an important influence on the nucleation and growth of 1D Tungsten Oxide (WO_x) nanorods. WO_x is a transition metal oxide, the nanostructuring of which can lead to unique characteristics. The photochromic and electrochromic properties of WO_x in nanostructured thin films have been increasingly investigated and applied to the development of devices. Nanostructured WO_x is also a well-studied material for photocatalysis and sensing; in its nanorod form, WO_x is also appealing for field emitting purposes. In this work, 1D Tungsten oxide nanorods are grown by Pulsed Laser Deposition (PLD) at the surface of amorphous-like Tungsten thin films on Silicon substrates, under a variety of conditions. The growing conditions are correlated to the different structural features of the nanorods with the help

of the SAM investigation, providing an assessment of the local chemical conditions at film surface. It is shown that, although the oxygen concentration in the bulk of the tungsten oxide films depends strongly on the oxygen partial pressure during deposition, the oxygen is not chemically bound to the W atoms to form a stable compound. Rather it is adsorbed at the large interface area provided by the nanoscale grain boundaries of the quasi-amorphous Tungsten film. This finding explains the need for a thermal annealing to promote the growth of Tungsten oxide nanorods, which however require also other local concurrent conditions to nucleate and develop like the material strain or curvature. By the unique surface sensitivity of SAM, it is shown that the Tungsten oxidation arrives at the film surface under selected mechanical conditions, and that a high surface mobility of the oxygen atoms is needed to overcome the difference between the lower film concentration and the higher oxygen stoichiometry in the nanorods. The second section deals with the thickness characterization on graphene and graphene oxide flakes on different substrates by Auger electron microscopy. Graphene and graphene oxide

flakes are routinely produced nowadays with thicknesses ranging from single atomic layers (0.3 nm and about 1 nm, respectively) to few layers. They belongs to a wider class of thin film materials that can be obtained from bulk layered materials, which form crystals with weakly bound layers. Graphite (the bulk form of carbon from which graphene has been firstly extracted) is the most common example and perhaps the most attractive due to the wide range of astonishing properties of graphene, its biocompatibility not to be forgotten. They are prototypical examples of 2D structures that can be used for the state-of-the-art and futures nanoscale devices. The family of layered compounds includes however other, sometime very interesting, examples; these include semiconductors or superconductors and present at the same time several other interesting properties, like charge density waves and phase transitions connected to them. In this work, it is shown that the state-of-the-art thickness characterization by SAM, based on semi-empirical electron Effective Attenuation Lengths (EAL), can bring to uncertainties largely exceeding the single layer thickness. To overcome this limitation, EALs are experimentally determined by

the simultaneous exploitation of AFM profiles at flake border, providing an absolute thickness reference, and of SAM, providing highly reliable values. The direct determination of the EALs allows to obtain sub-monolayer precision in the determination of the layer thickness by SAM, at any point inside the flake surface. The approach is experimentally demonstrated on graphene and graphene oxide (GO) flakes, over conductive and insulating substrates, which are representative of a large variety of applications. The sensitivity of the graphene thickness characterization on SiO_2 substrates, already demonstrated, is increased and, more important, these results extend the field of application of SAM characterization considerably beyond the present practice, to graphene oxide films and to metallic substrates, which are hardly accessible by the more acknowledged μ -Raman approach. Moreover, the SAM characterization boosts the relevant advantage of accessing any point of the full film area, while the direct thickness measurement by AFM are limited to the proximity of film borders. This advantage is shared with μ -Raman, which has other limitations such as the reduction of the GO sheets by the laser irradiation. These

achievements are promising in view of a wider control for the large area devices based on graphene and its oxide with reliable directly seeing of structural defects, and quantitatively detect chemical impurity on almost any substrate. Finally, it has been demonstrated the possibility to get information on the thickness of graphene and GO flakes by secondary electron contrast with the typical SEM resolution, down to the nm scale, once a proper reference is given. As the Auger microspectroscopy is often associated to SEM in the same apparatus and it is now able to provide the absolute reference, this demonstration pave the way to the high lateral resolution characterization of large area graphene and GO films with sub-monolayer resolution on a very wide variety of substrates, with properties ranging from conductors to insulators and from heavy to light atomic weight compounds.